

SAMSUNG**ELECTRONICS**

Approval



TO

DATE : Nov. 28, 2008

SAMSUNG TFT-LCD**MODEL NO. : LTN156AT01-H01**

NOTE : Extension code [-H01]
 → LTN156AT01-**H01**
 Surface type [**Glare**]

Any Modification of Spec is not allowed without SEC' permission.

APPROVED BY :

K. H. Shin

PREPARED BY :

Jay Kim

Application engineering part, Mobile Division
Samsung Electronics Co., Ltd.

**Samsung Secret**

Doc.No.	LTN156AT01-H01	Rev.No	04-A00-0-081128	Page	1 / 30
---------	----------------	--------	-----------------	------	--------

Approval

CONTENTS

Revision History	----- (3)
General Description	----- (4)
1. Absolute Maximum Ratings	----- (5)
1.1 Environmental Absolute Ratings	
1.2 Electrical Absolute Ratings	
2. Optical Characteristics	----- (7)
3. Electrical Characteristics	----- (10)
3.1 TFT LCD Module	
3.2 Back-light Unit	
4. Block Diagram	----- (13)
4.1 TFT LCD Module	
4.2 Backlight Unit	
5. Input Terminal Pin Assignment	----- (14)
5.1 Input Signal & Power	
5.2 LVDS Interface	
5.3 Timing Diagrams of LVDS For Transmitting	
5.4 Input Signals, Basic Display Colors and Gray Scale of Each Color.	
5.5 Pixel format in the Display	
6. Interface Timing	----- (19)
6.1 Timing Parameters	
6.2 Timing Diagrams of interface Signal	
6.3 Power ON/OFF Sequence	
7. Mechanical Outline Dimension	----- (21)
8. Packing	----- (23)
9. Markings & Others	----- (24)
10. General Precautions	----- (26)
11. EDID	----- (28)

Samsung Secret

Doc.No.	LTN156AT01-H01	Rev.No	04-A00-0-081128	Page	2 / 30
----------------	----------------	---------------	-----------------	-------------	--------

REVISION HISTORY

Approval

Date	Revision No.	Page	Summary
Nov. 28, 2008	A00	All	The approval specification of LTN156AT01-H01 model was issued first.

Samsung Secret

Approval

GENERAL DESCRIPTION**DESCRIPTION**

LTN156AT01 is a color active matrix TFT (Thin Film Transistor) liquid crystal display (LCD) that uses amorphous silicon TFT as switching devices. This model is composed of a TFT LCD panel, a driver circuit and a backlight unit. The resolution of a 15.6" contains 1366 x 768 pixels and can display up to 262,144 colors. 6 O'clock direction is the optimum viewing angle.

FEATURES

- Thin and light weight
- High contrast ratio, high aperture structure
- 1366 x 768 pixels resolution (16:9)
- Fast Response Time
- Low power consumption
- DE (Data enable) only mode
- 3.3V LVDS Interface
- On board EDID chip
- Pb-free product
- RoHS compliance

APPLICATIONS

- Notebook PC
- If the usage of this product is not for PC application, but for others, please contact SEC

GENERAL INFORMATION

Item	Specification	Unit	Note
Display area	344.232(H) x 193.536(V) (15.6" HD diagonal)	mm	
Driver element	a-Si TFT active matrix		
Display colors	262,144		
Number of pixel	1366 x 768	pixel	16:9
Pixel arrangement	RGB vertical stripe		
Pixel pitch	0.252(H) x 0.252(V) (TYP.)	mm	
Display Mode	Normally white		
Glass Thickness	0.5T	mm	
Surface treatment	Haze 0, Hard-Coating 3H		

Samsung Secret

Doc.No.	LTN156AT01-H01	Rev.No	04-A00-0-081128	Page	4 / 30
----------------	----------------	---------------	-----------------	-------------	--------

Approval

Mechanical Information

Item		Min.	Typ.	Max.	Unit	Note
Module size	Horizontal (H)	358.8	359.3	359.8	mm	
	Vertical (V)	209.0	209.5	210.0	mm	
	Depth (D)	-	-	6.2	mm	(1)
Weight		-	520	550	g	

Note (1) Measurement condition of outline dimension
 . Equipment : Bernier Calipers
 . Push Force : 500g · f (minimum)

1. ABSOLUTE MAXIMUM RATINGS

1.1 ENVIRONMENTAL ABSOLUTE RATINGS

Item	Symbol	Min.	Max.	Unit	Note
Storage temperate	TSTG	-20	60	°C	(1)
Operating temperate (Temperature of glass surface)	TOPR	0	50	°C	(1)
Shock (non-operating)	Snop	-	240	G	(2),(4)
Vibration (non-operating)	Vnop	-	2.41	G	(3),(4)

Note (1) Temperature and relative humidity range are shown in the figure below.
 95 % RH Max. (40 °C ≥ Ta)
 Maximum wet - bulb temperature at 39 °C or less. (Ta > 40 °C) No condensation

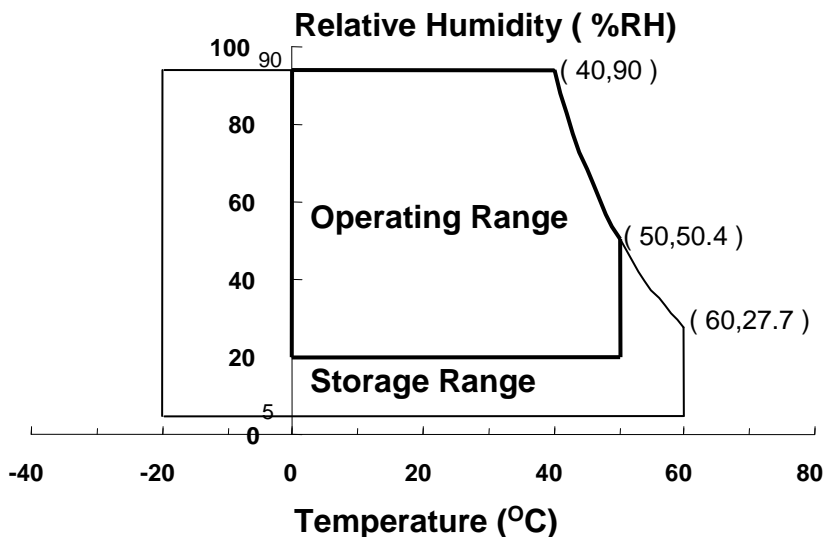

- (2) 2ms, half sine wave, one time for ±X, ±Y, ±Z.
- (3) 5 - 500 Hz, random vibration, 30min for X, Y, Z.
- (4) At testing Vibration and Shock, the fixture in holding the Module to be tested have to be hard and rigid enough so that the Module would not be twisted or bent by the fixture.

Samsung Secret

Approval

1.2 ELECTRICAL ABSOLUTE RATINGS

(1) TFT LCD MODULE

 $V_{DD} = 3.3V, V_{SS} = GND = 0V$

Item	Symbol	Min.	Max.	Unit	Note
Power Supply Voltage	V_{DD}	$V_{DD} - 0.3$	$V_{DD} + 0.3$	V	(1)
Logic Input Voltage	V_{IN}	$V_{DD} - 0.3$	$V_{DD} + 0.3$	V	(1)

Note (1) Within T_a ($25 \pm 2 \text{ }^\circ\text{C}$)

(2) BACK-LIGHT UNIT

 $T_a = 25 \pm 2 \text{ }^\circ\text{C}$

Item	Symbol	Min.	Max.	Unit	Note
Lamp Current	I_L	2.0	6.5	mArms	(1)
Lamp frequency	F_L	50	80	kHz	(1)

Note 1) Permanent damage to the device may occur if maximum values are exceeded
 Functional operation should be restricted to the conditions described under normal operating conditions.

Samsung Secret

Doc.No.	LTN156AT01-H01	Rev.No	04-A00-0-081128	Page	6 / 30
---------	----------------	--------	-----------------	------	--------

Approval

2. OPTICAL CHARACTERISTICS

The following items are measured under stable conditions. The optical characteristics should be measured in a dark room or equivalent state with the methods shown in Note (5).
Measuring equipment : TOPCON SR-3

* Ta = 25 ± 2 °C, VDD=3.3V, fv= 60Hz, fdCLK = 69.3MHz, IL = 6.0 mA

Item		Symbol	Condition	Min.	Typ.	Max	Unit	Note
Contrast Ratio (5 Points)		CR	Normal Viewing Angle $\phi = 0$ $\theta = 0$	500	600	-	-	(1), (2), (5)
Response Time at Ta (Rising + Falling)		T _{RT}		-	25	35	msec	(1), (3)
Average Luminance of White (5 Points)		Y _{L,AVE}		170	200	-	cd/m ²	IL=6.0 mA (1), (4)
Color Chromaticity (CIE)	Red	R _X		0.593	0.623	0.653	-	(1), (5) SR-3
		R _Y		0.328	0.358	0.388		
	Green	G _X		0.273	0.303	0.333		
		G _Y		0.559	0.589	0.619		
	Blue	B _X		0.116	0.146	0.176		
		B _Y		0.070	0.100	0.130		
	White	W _X		0.283	0.313	0.343		
		W _Y	0.299	0.329	0.359			
Viewing Angle	Hor.	θ_L	CR ≥ 10 At center	40	45	-	Degrees	(1), (5) SR-3
		θ_H		40	45	-		
	Ver.	ϕ_H		10	15	-		
		ϕ_L		25	35	-		
13 Points White Variation		δ_L	-	-	1.6	-	(6)	

Samsung Secret

Approval

Note 1) Definition of Viewing Angle : Viewing angle range($10 \leq C/R$)

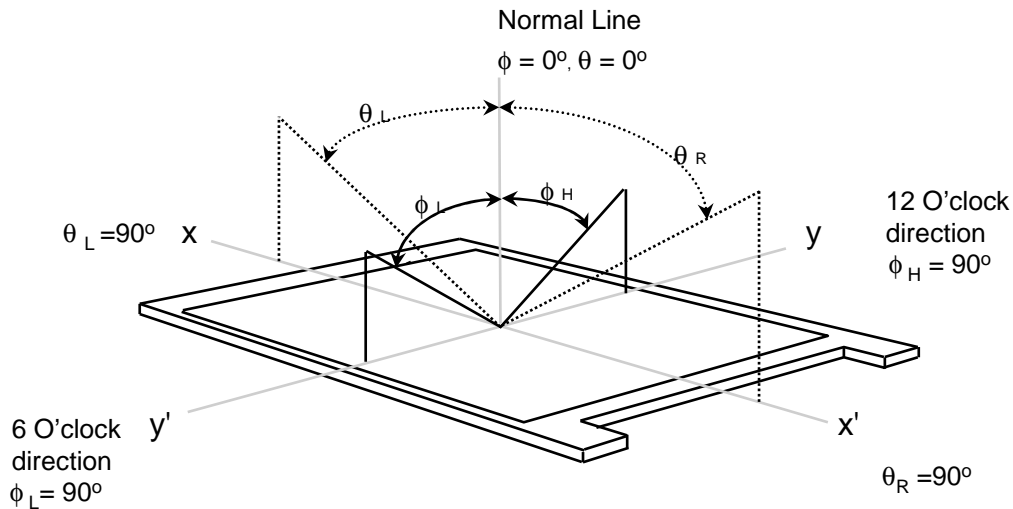

Note 2) Definition of Contrast Ratio (CR) : Ratio of gray max (Gmax) ,gray min (Gmin) at 5 points(4, 5, 7, 9, 10)

$$CR = \frac{CR(4) + CR(5) + CR(7) + CR(9) + CR(10)}{5}$$

Points : (4) , (5) , (7) , (9) , (10) at the figure of Note (6).

Note 3) Definition of Response time :

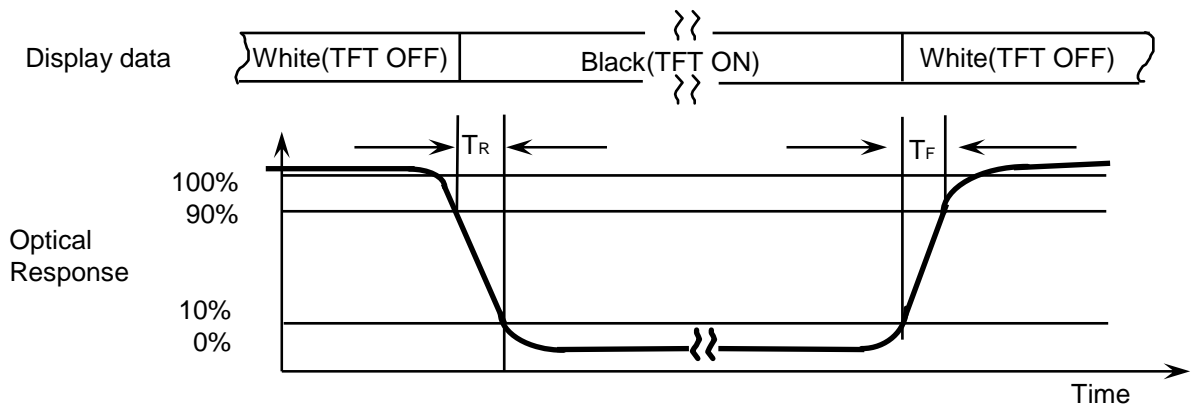

Note 4) Definition of Average Luminance of White : measure the luminance of white at 5 points.

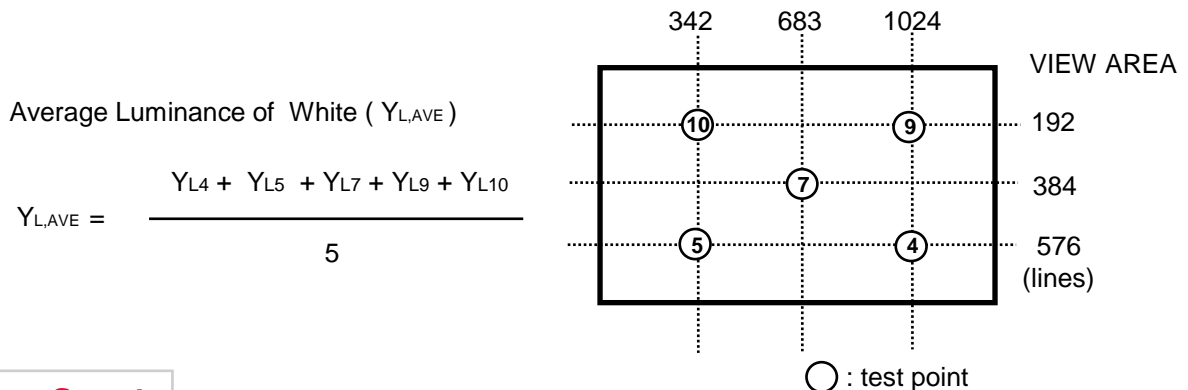

Samsung Secret

Approval

Note 5) After stabilizing and leaving the panel alone at a given temperature for 30 min , the measurement should be executed. Measurement should be executed in a stable, windless, and dark room. 30 min after lighting the backlight. This should be measured in the center of screen.
 IF current : 20.0mA
 Environment condition : Ta = 25 ± 2 °C

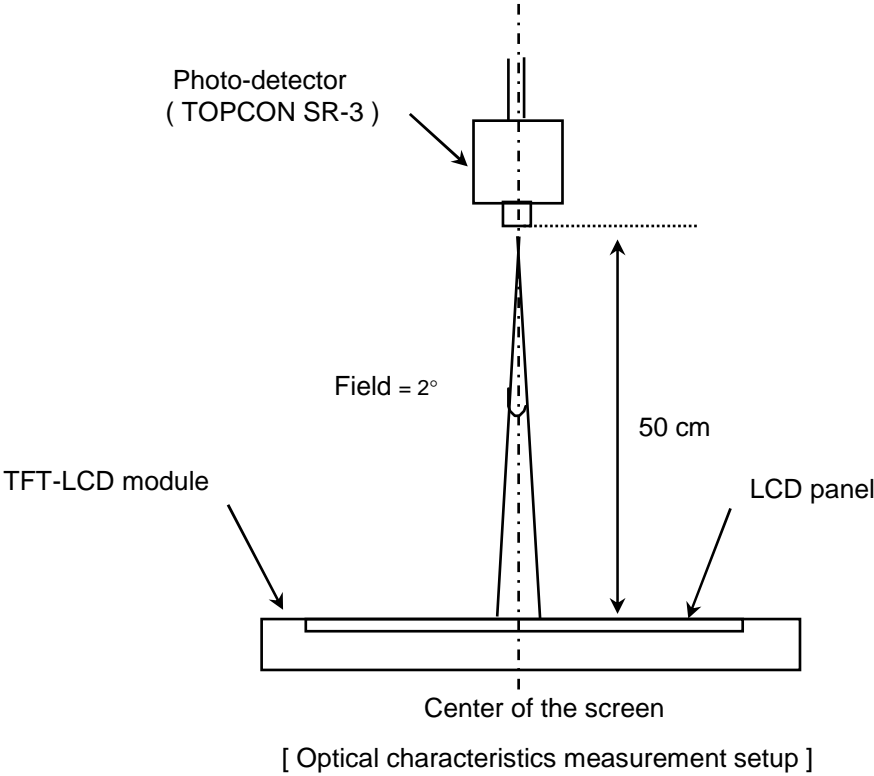

Note 6) Definition of 13 points white variation (δL), CR variation(C_{VER}) [① ~ ⑬]

$$\delta L = \frac{\text{Maximum luminance of 13 points}}{\text{Minimum luminance of 13 points}}$$

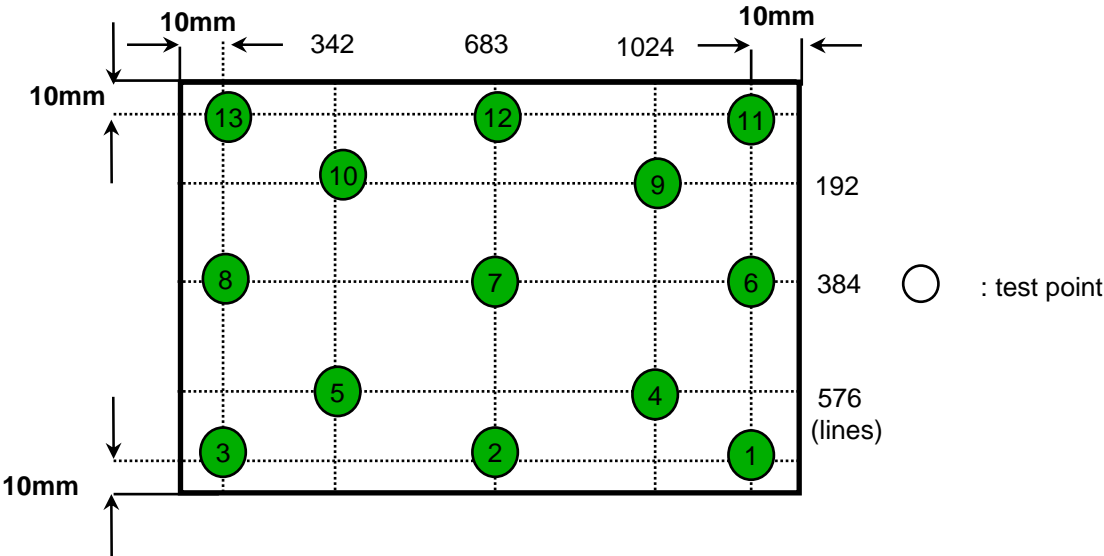

Samsung Secret

Approval

3. ELECTRICAL CHARACTERISTICS

3.1 TFT LCD MODULE

Ta= 25 ± 2°C

Item	Symbol	Min.	Typ.	Max.	Unit	Note	
Voltage of Power Supply	V _{DD}	3.0	3.3	3.6	V		
Differential Input Voltage for LVDS Receiver Threshold	High	V _{IH}	-	-	+100	mV	V _{CM} = +1.2V
	Low	V _{IL}	-100	-	-	mV	
Vsync Frequency	f _V	-	60	-	Hz		
Hsync Frequency	f _H	-	46.8	-	KHz		
Main Frequency	f _{DCLK}	67.3	69.3	71.5	MHz		
Rush Current	I _{RUSH}	-	-	1.5	A	(4)	
Current of Power Supply	White	I _{DD}	-	360	-	mA	(2),(3)*a
	Mosaic		-	420	-	mA	(2),(3)*b
	V. stripe		-	530	600	mA	(2),(3)*c

Note (1) Display data pins and timing signal pins should be connected.(GND = 0V)

(2) f_V = 60Hz, f_{DCLK} = 69.3MHz, V_{DD} = 3.3V , DC Current.

(3) Power dissipation pattern

*a) White Pattern

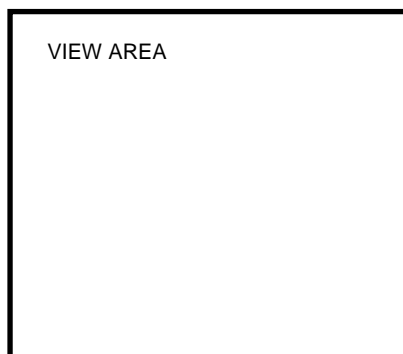

*b) Mosaic Pattern

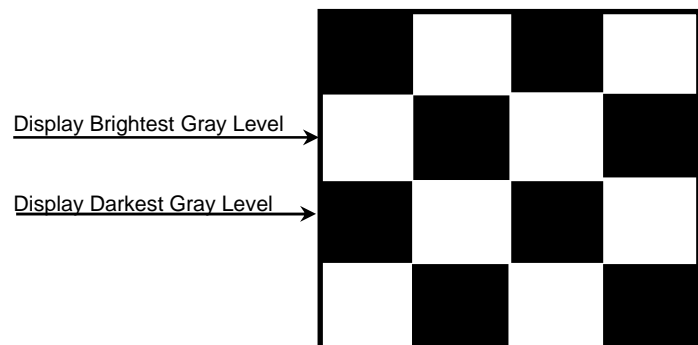

Samsung Secret

Doc.No.	LTN156AT01-H01	Rev.No	04-A00-0-081128	Page	10 / 30
---------	----------------	--------	-----------------	------	---------

Approval

*c) 1dot Vertical stripe pattern

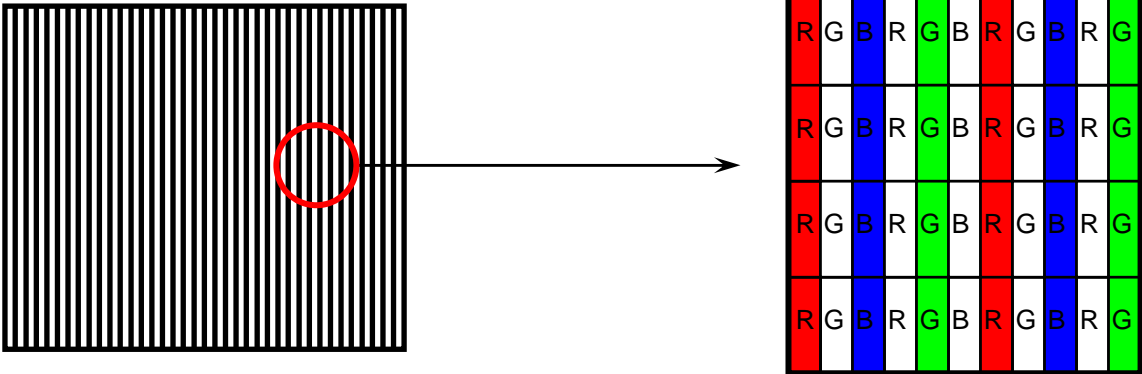

4) Rush current measurement condition

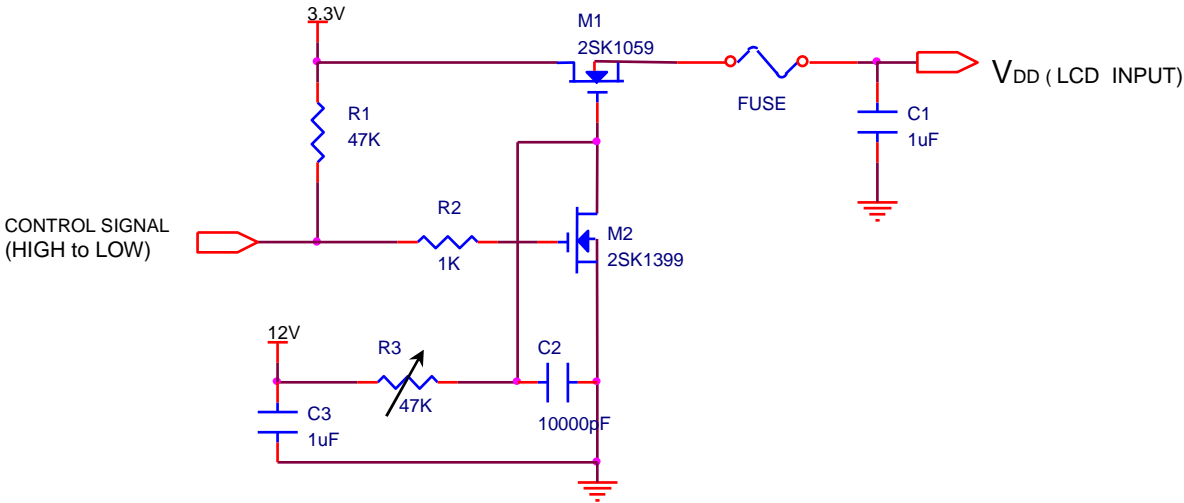

V_{DD} rising time is 470us

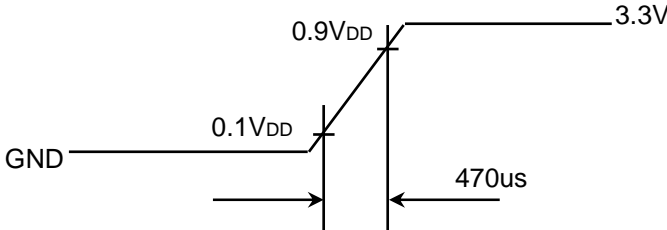

Samsung Secret

Approval

3.2 BACK-LIGHT UNIT

The backlight system is an edge-lighting type with a CCFL (Cold Cathode Fluorescent Lamp).
The characteristics of a single lamp are shown in the following tables.

- INVERTER : (SEM SI 1700)

Ta= 25 ± 2 °C

Item	Symbol	Min.	Typ.	Max.	Unit	Note
Lamp Current	I _L	3.0	6.0	6.5	mArms	(1)
Lamp Voltage	V _L	-	705	-	Vrms	I _L =6.0mA
Frequency	f _L	48	60	65	KHz	(2)
Power Consumption	P _L		4.5		W	(3) I _L =6.0mA
Operating Life Time	Hr	12,000			Hour	(4)
Startup Voltage	V _s	-	-	1300	Vrms	25°C, (5)
				1480	Vrms	0°C, (5)
Lamp startup time		-	-	1.0	sec	(5)

Note) The waveform of the inverter output voltage must be area symmetric and the design of the inverter must have specifications for the modularized lamp.

The performance of the backlight, for example life time or brightness, is much influenced by the characteristics of the DC-AC inverter for the lamp. So all the parameters of an inverter should be carefully designed so as not to produce too much leakage current from high-voltage output of the inverter. When you design or order the inverter, please make sure that a poor lighting caused by the mismatch of the backlight and the inverter(miss lighting, flicker, etc.) never occur. When you confirm it, the module should be operated in the same condition as it is installed in your instrument.

Note (1) Lamp current is measured with a high frequency current meter as shown below.

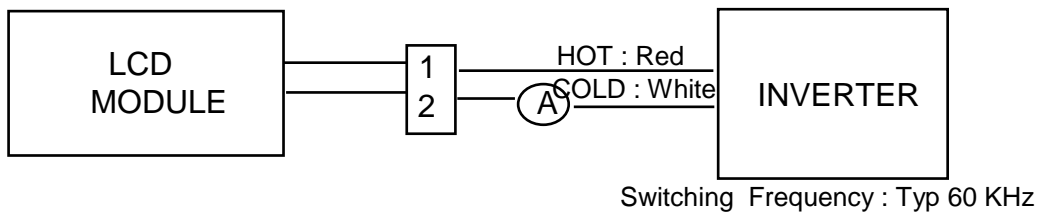

- (2) Lamp frequency may produce interference with horizontal synchronous frequency and this may cause line flow on the display. Therefore lamp frequency should be detached from the horizontal synchronous frequency and its harmonics as far as possible in order to avoid interference.
- (3) Refer to I_L × V_L to calculate.
- (4) Life time (Hr) of a lamp can be defined as the time in which it continues to operate under the condition Ta= 25 ± 2 °C and I_L = 6.5 mArms until one of the following event occurs.
 - 1. When the brightness becomes 50% or lower than the original.
 - 2. When the Effective ignition length becomes 80% or lower than the original value.
(Effective ignition length is defined as an area that has less than 70% brightness compared to the brightness in the center point.)
- (5) The inverter open voltage - this voltage should be measured after ballast capacitor- have to be larger than the lamp startup voltage, otherwise backlight may has blinking for a moment after turns on or not be turned on.
If an inverter has shutdown function it should keep its open voltage for longer than 1 second even if lamp connector open.

Samsung Secret

Approval

4. BLOCK DIAGRAM

4.1 TFT LCD Module

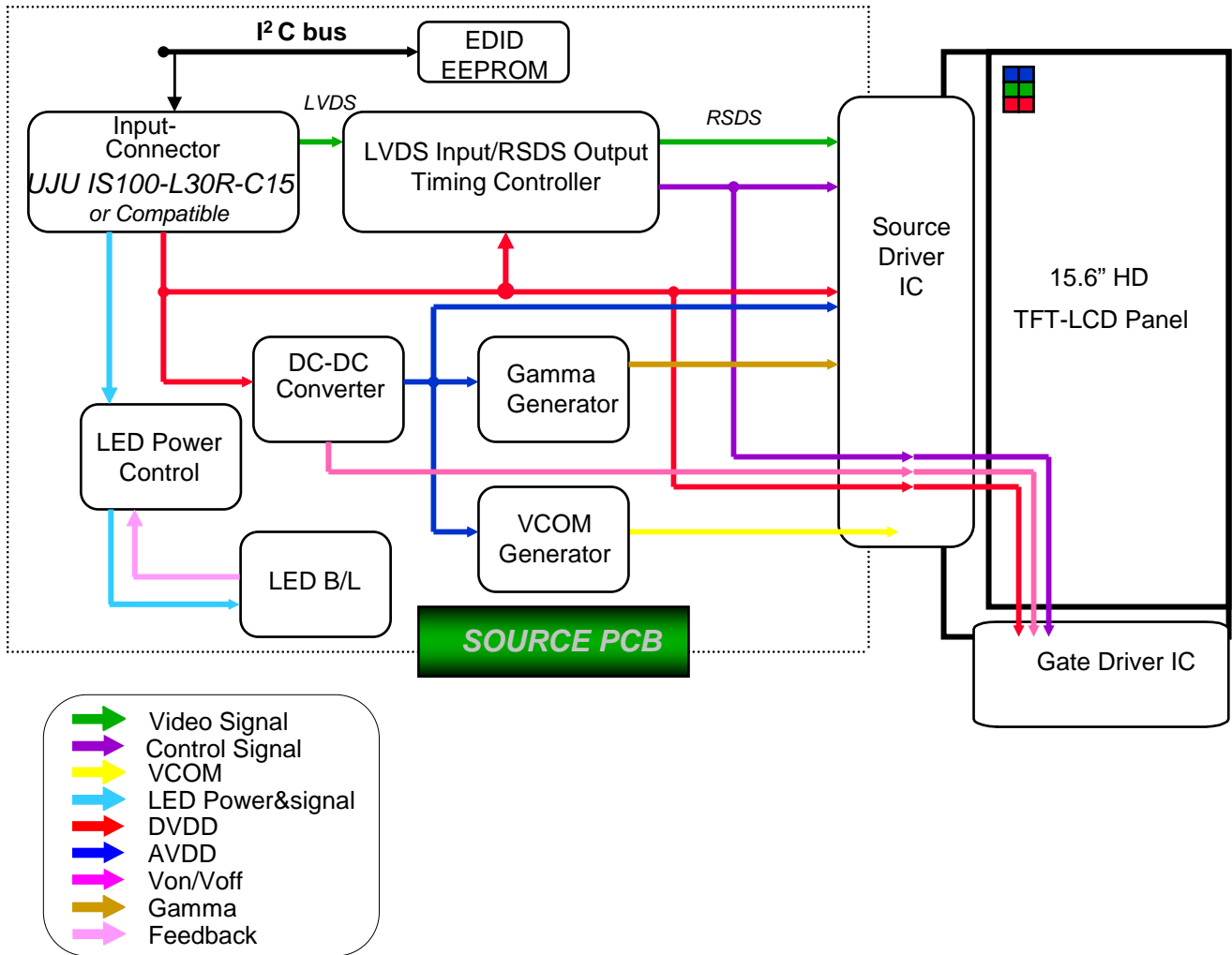

4.2 BACK-LIGHT UNIT

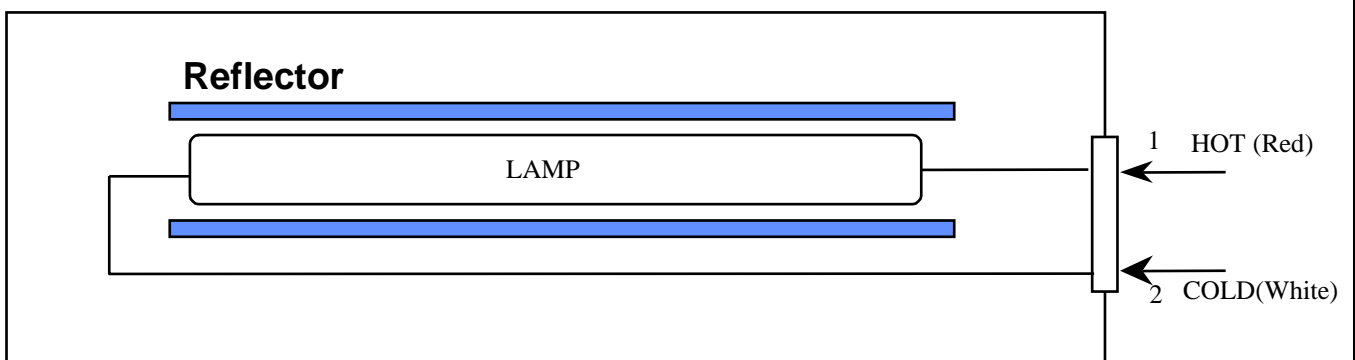

Note) The output of the inverter may change according to the material of the reflector.

Samsung Secret

Doc.No.	LTN156AT01-H01	Rev.No	04-A00-0-081128	Page	13 / 30
---------	----------------	--------	-----------------	------	---------

Approval

5. INPUT TERMINAL PIN ASSIGNMENT

5.1. Input Signal & Power (LVDS, Connector : UJU IS100-L30R-C15 or compatible)
Mating Connector : JAE FI-X30M or compatible)

PIN NO	SYMBOL	FUNCTION	POLARITY	REMARK
1	VSS	Ground		
2	VDD	POWER SUPPLY +3.3V		
3	VDD	POWER SUPPLY +3.3V		
4	VEEDID	DDC 3.3V Power		
5	TEST	Panel Self Test		
6	CLKEDID	DDC Clock		
7	DATAEDID	DDC data		
8	RxIN0-	LVDS Differential Data INPUT (R0-R5,G0)	Negative	
9	RxIN0+	LVDS Differential Data INPUT (R0-R5,G0)	Positive	
10	VSS	Ground		
11	RxIN1-	LVDS Differential Data INPUT (G1-G5,B0-B1)	Negative	
12	RxIN1+	LVDS Differential Data INPUT (G1-G5,B0-B1)	Positive	
13	VSS	Ground		
14	RxIN2-	LVDS Differential Data INPUT (B2-B5,Sync,DE)	Negative	
15	RxIN2+	LVDS Differential Data INPUT (B2-B5,Sync,DE)	Positive	
16	VSS	Ground		
17	RxCLK-	LVDS Differential Data INPUT (Clock)	Negative	
18	RxCLK+	LVDS Differential Data INPUT (Clock)	Positive	
19	VSS	Ground		
20	NC	No Connection		
21	NC	No Connection		
22	VSS	No Connection		
23	NC	No Connection		
24	NC	No Connection		
25	VSS	No Connection		
26	NC	No Connection		
27	NC	No Connection		
28	VSS	No Connection		
29	NC	No Connection		
30	NC	No Connection		

Samsung Secret

Approval

5.2 LVDS Interface : Transmitter DS90CF363 or Compatible

Pin No.	Name	RGB Signal	Pin No.	Name	RGB Signal
51	TxIN0	R0	14	TxIN14	G5
52	TxIN1	R1	15	TxIN15	B0
54	TxIN2	R2	19	TxIN18	B1
55	TxIN3	R3	20	TxIN19	B2
56	TxIN4	R4	22	TxIN20	B3
3	TxIN6	R5	23	TxIN21	B4
4	TxIN7	G0	24	TxIN22	B5
6	TxIN8	G1	27	TxIN24	Hsync
7	TxIN9	G2	28	TxIN25	Vsync
11	TxIN12	G3	30	TxIN26	DE
12	TxIN13	G4	31	TxCLKIN	Clock

LVDS INTERFACE

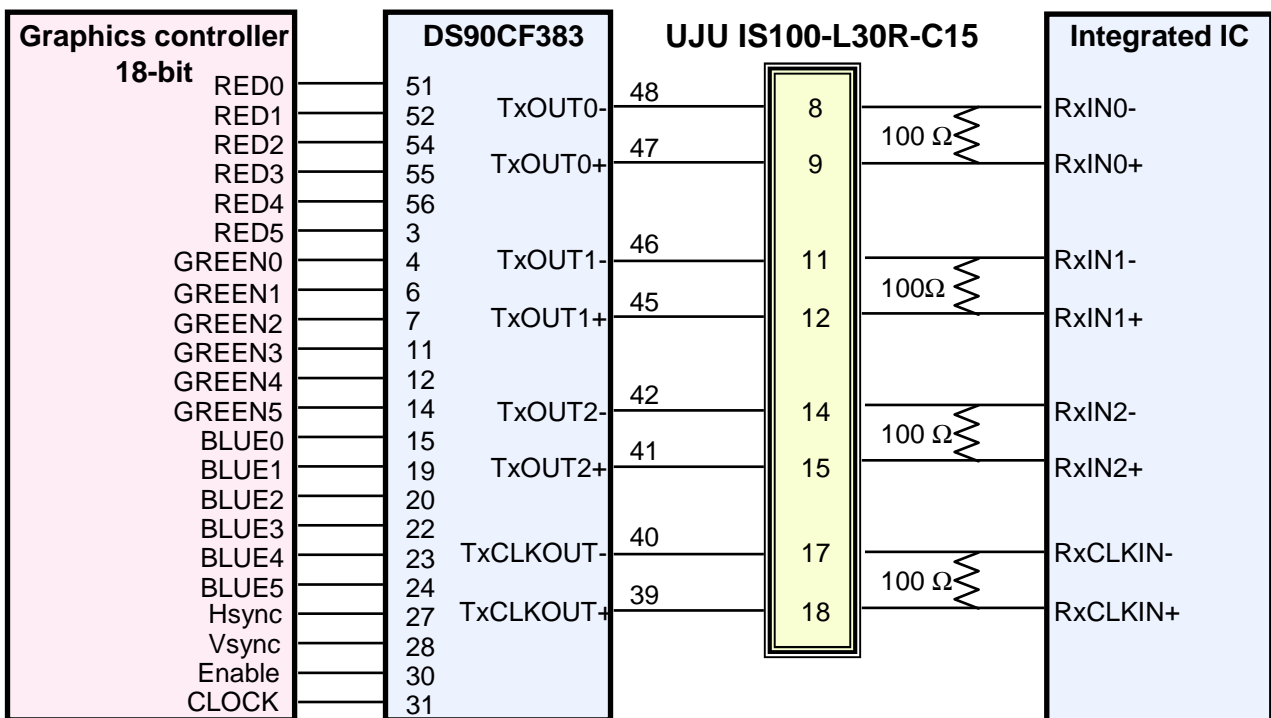

Note : The LCD Module uses a 100ohm resistor between positive and negative lines of each receiver input.

Samsung Secret

Approval

5.3 Timing Diagrams of LVDS For Transmission

LVDS Receiver : Integrated T-CON

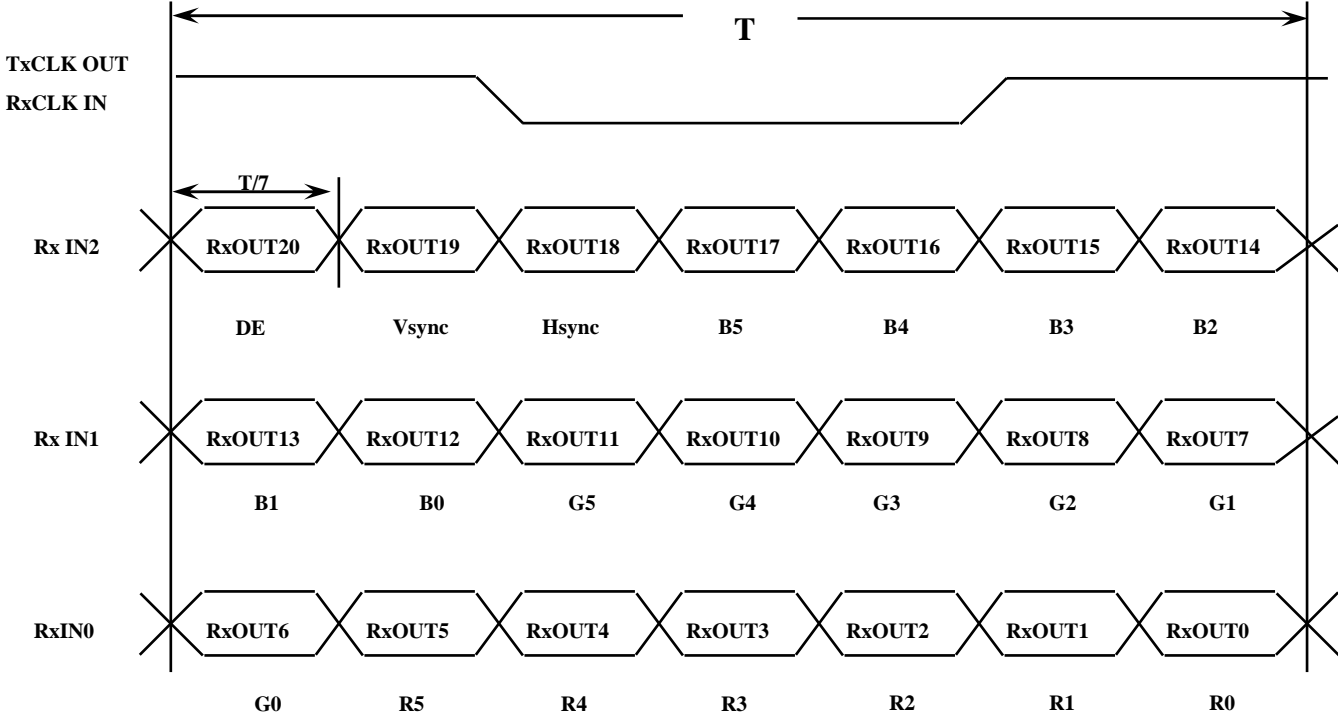

Samsung Secret

Approval

5.4 Input Signals, Basic Display Colors and Gray Scale of Each Color

Color	Display	Data Signal																Gray Scale Level	
		Red					Green					Blue							
		R0	R1	R2	R3	R4	R5	G0	G1	G2	G3	G4	G5	B0	B1	B2	B3		45
Basic Colors	Black	0	0	0	0	0	0	0	0	0	0	0	0	0	0	0	0	0	-
	Blue	0	0	0	0	0	0	0	0	0	0	0	0	1	1	1	1	1	-
	Green	0	0	0	0	0	0	1	1	1	1	1	1	0	0	0	0	0	-
	Cyan	0	0	0	0	0	0	1	1	1	1	1	1	1	1	1	1	1	-
	Red	1	1	1	1	1	1	0	0	0	0	0	0	0	0	0	0	0	-
	Magenta	1	1	1	1	1	1	0	0	0	0	0	0	1	1	1	1	1	-
	Yellow	1	1	1	1	1	1	1	1	1	1	1	1	0	0	0	0	0	-
	White	1	1	1	1	1	1	1	1	1	1	1	1	1	1	1	1	1	-
Gray Scale Of Red	Black	0	0	0	0	0	0	0	0	0	0	0	0	0	0	0	0	0	R0
	Dark	1	0	0	0	0	0	0	0	0	0	0	0	0	0	0	0	0	R1
	↑	0	1	0	0	0	0	0	0	0	0	0	0	0	0	0	0	0	R3-R60
	:	:	:	:	:	:	:	:	:	:	:	:	:	:	:	:	:	:	
	:	:	:	:	:	:	:	:	:	:	:	:	:	:	:	:	:	:	
	↓	1	0	1	1	1	1	0	0	0	0	0	0	0	0	0	0	0	R61
	Light	0	1	1	1	1	1	0	0	0	0	0	0	0	0	0	0	0	R62
	Red	1	1	1	1	1	1	0	0	0	0	0	0	0	0	0	0	0	R63
Gray Scale Of Green	Black	0	0	0	0	0	0	0	0	0	0	0	0	0	0	0	0	0	G0
	Dark	0	0	0	0	0	0	1	0	0	0	0	0	0	0	0	0	0	G1
	↑	0	0	0	0	0	0	0	1	0	0	0	0	0	0	0	0	0	G3-G60
	:	:	:	:	:	:	:	:	:	:	:	:	:	:	:	:	:	:	
	:	:	:	:	:	:	:	:	:	:	:	:	:	:	:	:	:	:	
	↓	0	0	0	0	0	0	1	0	1	1	1	1	0	0	0	0	0	G61
	Light	0	0	0	0	0	0	0	1	1	1	1	1	0	0	0	0	0	G62
	Green	0	0	0	0	0	0	1	1	1	1	1	1	0	0	0	0	0	G63
Gray Scale Of Blue	Black	0	0	0	0	0	0	0	0	0	0	0	0	0	0	0	0	0	B0
	Dark	0	0	0	0	0	0	0	0	0	0	0	0	1	0	0	0	0	B1
	↑	0	0	0	0	0	0	0	0	0	0	0	0	0	1	0	0	0	B3-B60
	:	:	:	:	:	:	:	:	:	:	:	:	:	:	:	:	:	:	
	:	:	:	:	:	:	:	:	:	:	:	:	:	:	:	:	:	:	
	↓	0	0	0	0	0	0	0	0	0	0	0	0	1	0	1	1	1	B61
	Light	0	0	0	0	0	0	0	0	0	0	0	0	0	1	1	1	1	B62
	Blue	0	0	0	0	0	0	0	0	0	0	0	0	1	1	1	1	1	B63

Note 1) Definition of gray :

Rn: Red gray, Gn: Green gray, Bn: Blue gray (n=gray level)

Note 2) Input signal: 0 =Low level voltage, 1=High level voltage

Samsung Secret

Approval

5.5 Pixel Format in the display

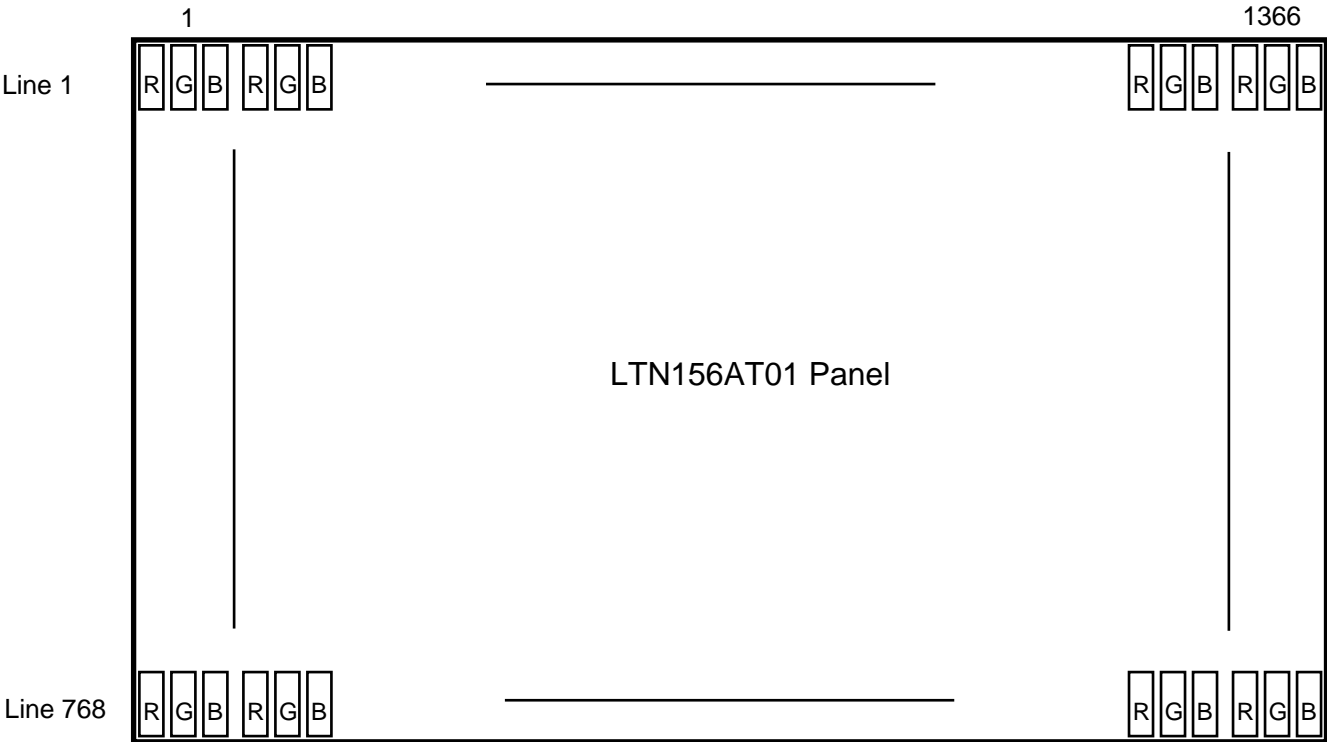

Samsung Secret

6. INTERFACE TIMING

6.1 Timing Parameters

Signal	Item	Symbol	Min.	Typ.	Max.	Unit	Note
Frame Frequency	Cycle	TV	774	780	810	Lines	
Vertical Active Display Term	Display Period	TV _D	-	768	-	Lines	
One Line Scanning Time	Cycle	TH	1430	1480	1530	Clocks	
Horizontal Active Display Term	Display Period	TH _D	-	1366	-	Clocks	

6.2 Timing diagrams of interface signal

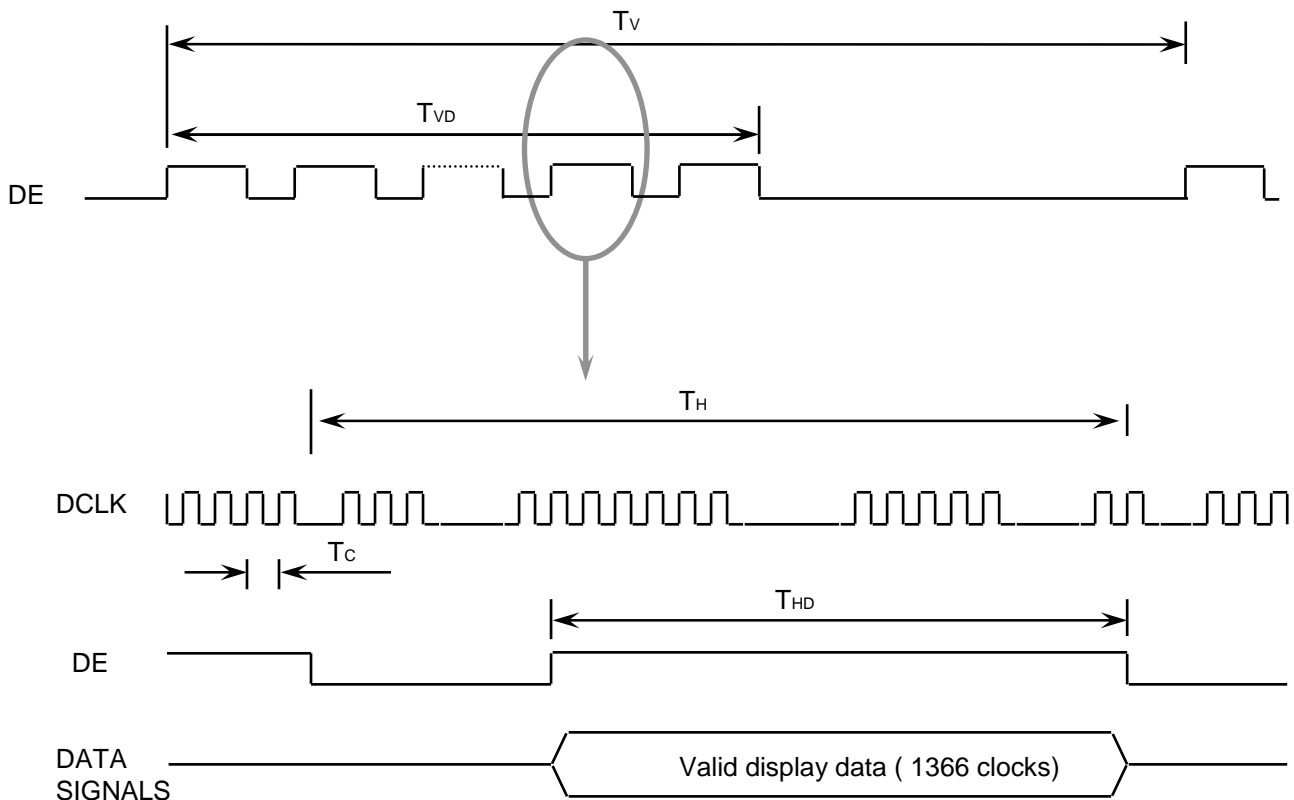

Samsung Secret

6.3 Power ON/OFF Sequence

Approval

: To prevent a latch-up or DC operation of the LCD module, the power on/off sequence should be as the diagram below.

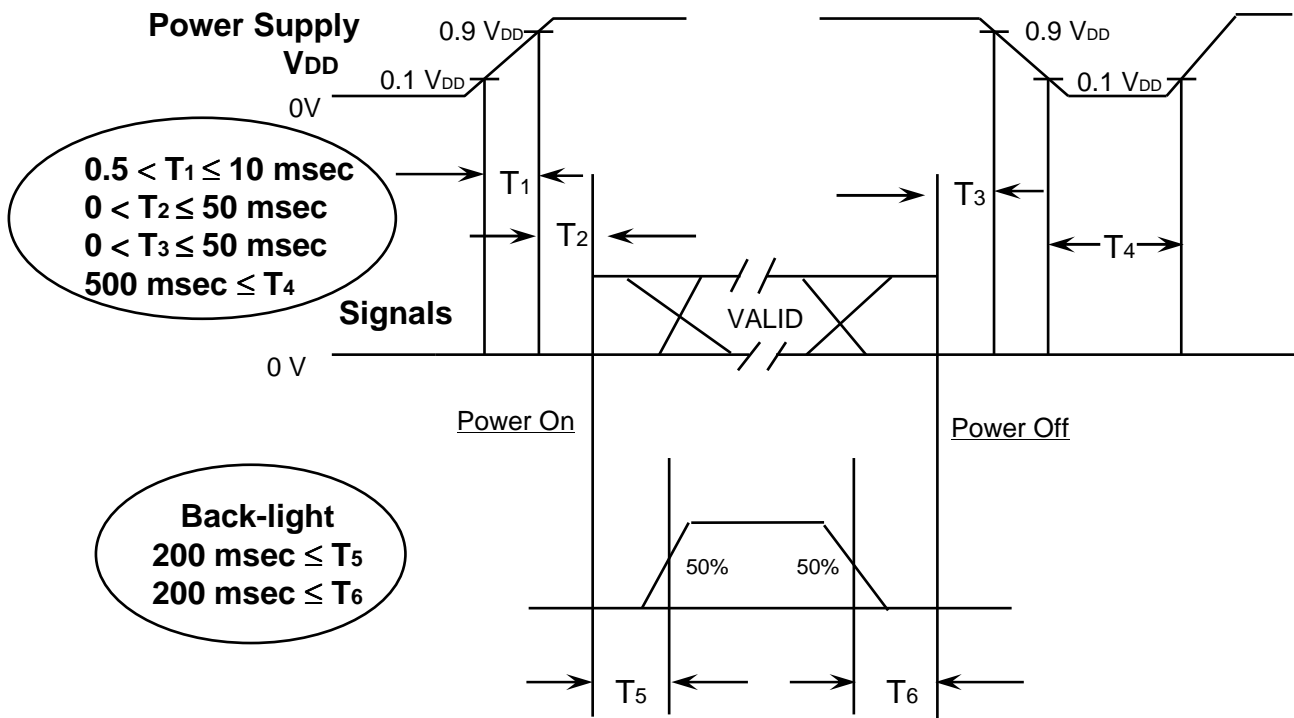
Power ON/OFF Sequence

- T1 : Vdd rising time from 10% to 90%
- T2 : The time from Vdd to valid data at power ON.
- T3 : The time from valid data off to Vdd off at power Off.
- T4 : Vdd off time for Windows restart
- T5 : The time from valid data to B/L enable at power ON.
- T6 : The time from valid data off to B/L disable at power Off.

NOTE.

- (1) The supply voltage of the external system for the module input should be the same as the definition of V_{DD}.
- (2) Apply the lamp voltage within the LCD operation range. When the back-light turns on before the LCD operation or the LCD turns off before the back-light turns off, the display may momentarily become white.
- (3) In case of V_{DD} = off level, please keep the level of input signals on the low or keep a high impedance.
- (4) T₄ should be measured after the module has been fully discharged between power off and on period.
- (5) Interface signal shall not be kept at high impedance when the power is on.

Samsung Secret

Doc.No.	LTN156AT01-H01	Rev.No	04-A00-0-081128	Page	20 / 30
---------	----------------	--------	-----------------	------	---------

Approval

7. Mechanical Outline Dimension

Refer to the next page

Samsung Secret

Doc.No.	LTN156AT01-H01	Rev.No	04-A00-0-081128	Page	21 / 30
----------------	----------------	---------------	-----------------	-------------	---------

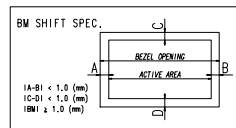
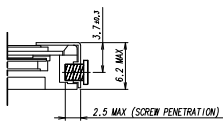
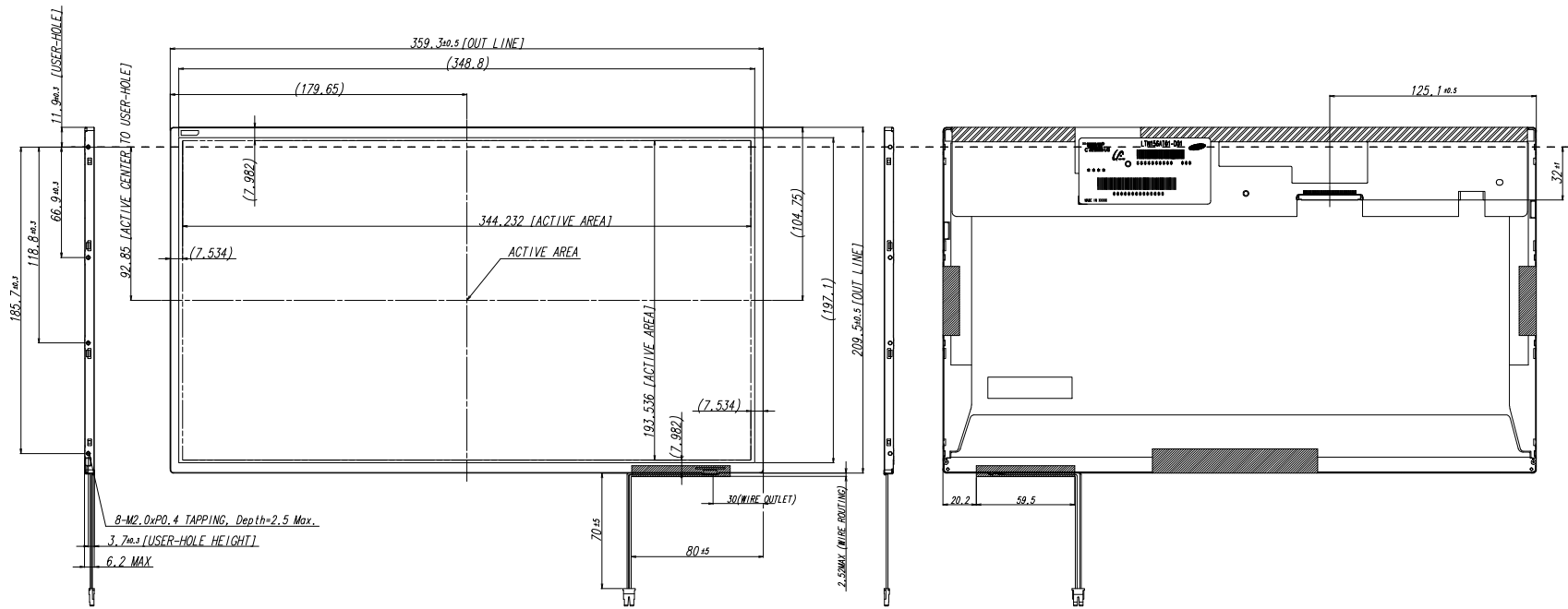

<USER HOLE SCREW PENETRATION DEPTH>

* NOTE

- SIGNAL INTERFACE CONNECTOR TO BE SPECIFIED AS BELOW.
 - MAKER : UJU OR COMPATIBLE
 - INPUT CONNECTOR : UJU IS100-L30R-L15
- LAMP CONNECTOR FOR BACKLIGHT TO BE SPECIFIED AS BELOW.
 - MAKER : JST (TBD)
 - PART NO : BHSR-02VS-1 (TBD)
 - LAMP DIAMETER : ϕ 2.0
- ALLOWED DEPTH OF USERHOLE SCREW INSERTION IS MAX 2.5mm
- TORQUE SPEC : MAX 2.5 Kgf-cm (5TIMES)
- CALIFERS MEASURING FORCE : 750 150 gf
- WEIGHT : TYP 500, MAX 520 g (TBD)

REV	DATE	DESCRIPTION OF REVISION	REASON	CHK'D BY
01	11.08.08	INITIAL DESIGN		
02	11.08.08	DESIGN BY CHG BY APP'D BY		
03	11.08.08	J.A.LEE S.C.AOUC		
04	2008.08.21	2008.08.21		
SAMSUNG ELECTRONICS		SPEC. NO.	OUTLINE DIMENSION	SHEET 1/1
		880009-001		VER. 001

Approval

8. PACKING

1. CARTON(Internal Package)

(1) Packing Form

Corrugated Cardboard box and Corrupad form as shock absorber

(2) Packing Method

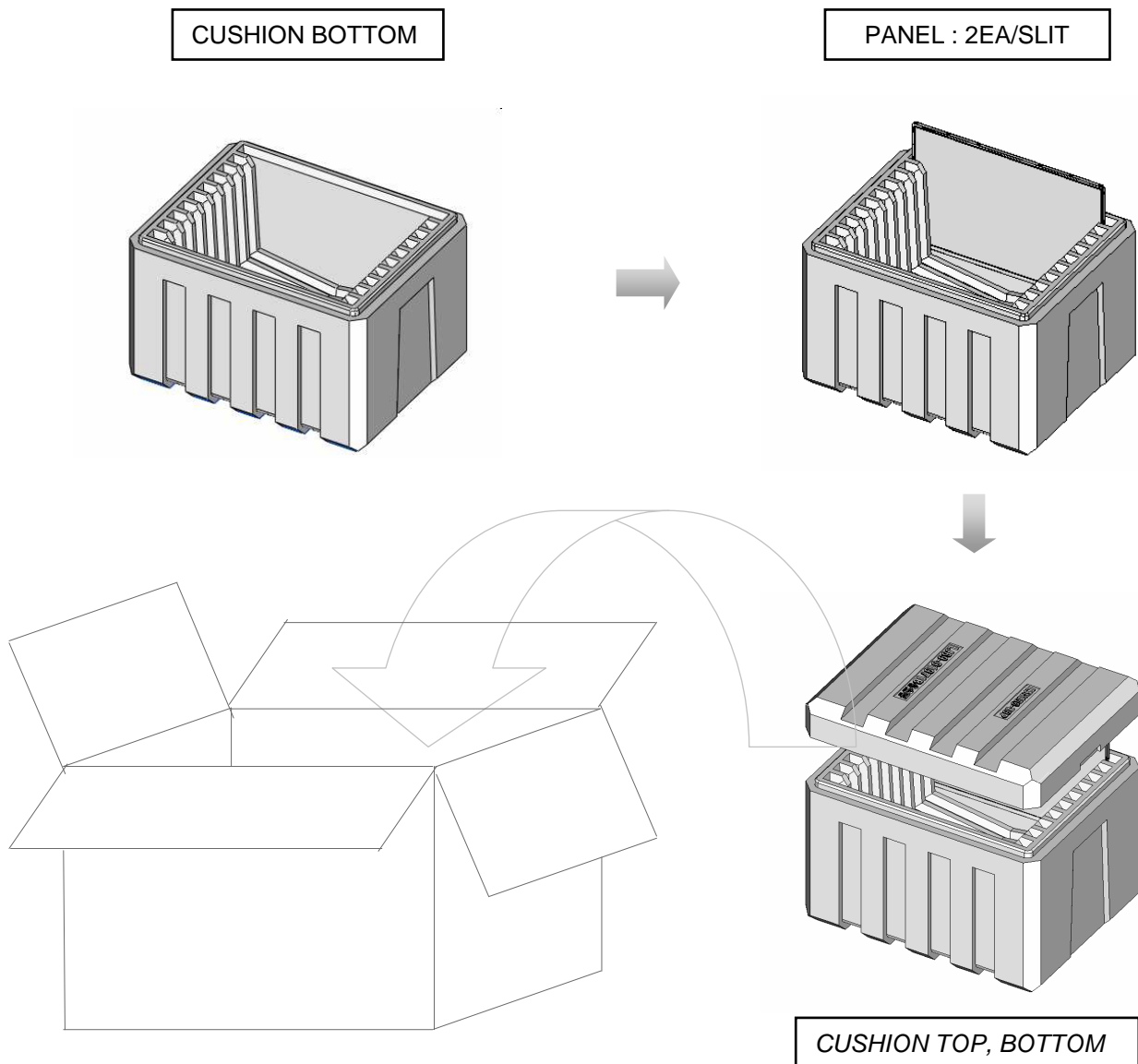

Note (1) Total : Approx. 12.4 Kg

(2) Acceptance number of piling : 20 sets

(3) Carton size : 344(W) X 432(D) X 329(H)

Samsung Secret

Doc.No.	LTN156AT01-H01	Rev.No	04-A00-0-081128	Page	23 / 30
----------------	----------------	---------------	-----------------	-------------	---------

Approval

(3)Packing Material

No	Part name	Quantity
1	Static electric protective sack	20
2	Packing case (Inner box) included shock absorber	1 set
3	Pictorial marking	2 pcs
4	Carton	1 set

9. MARKINGS & OTHERS

A nameplate bearing followed by is affixed to a shipped product at the specified location on each product.

- (1)Parts number : LTN156AT01
- (2)Revision code : 3 letters
- (3)Lot number : X X X X XXX XX X **H01**

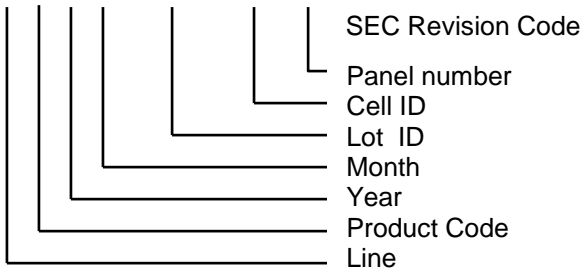

(4) Nameplate Indication

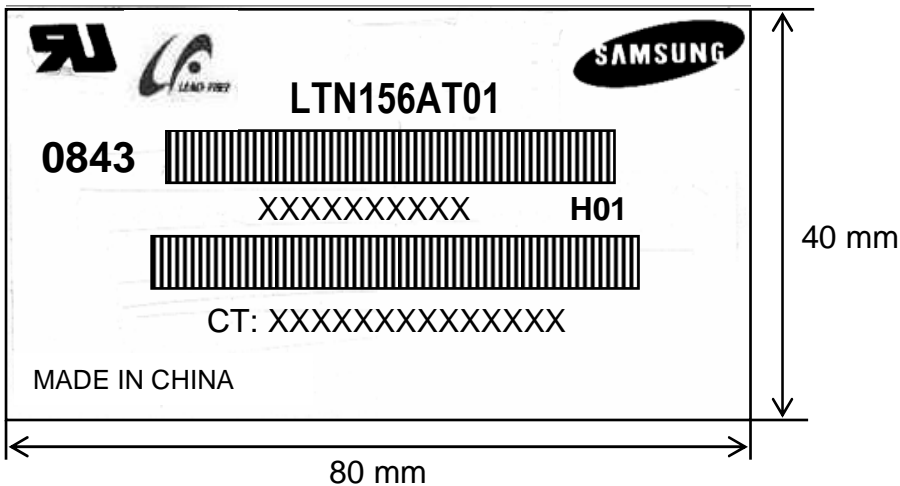

Parts name : LTN156AT01
 Lot number : XXXXXXXXXXXX
 Inspected work week : 0843 (2008 year 43rd week)
 Product Revision Code : H01
 CT code : XXXXXXXXXXXXXXXX (Released after HP's approval)

Samsung Secret

Approval

(5) High voltage caution notice

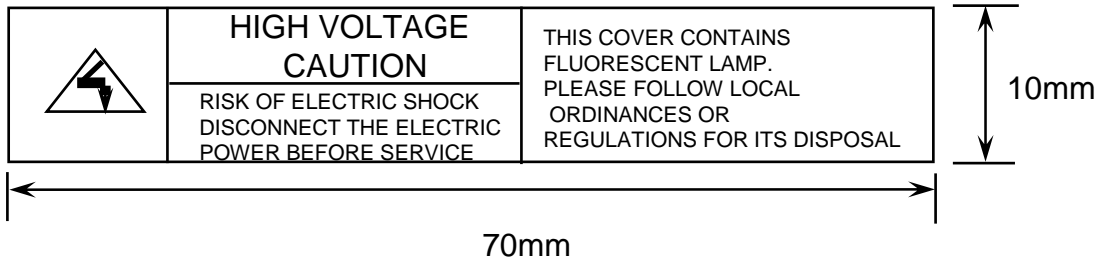

(6) Packing small box attach

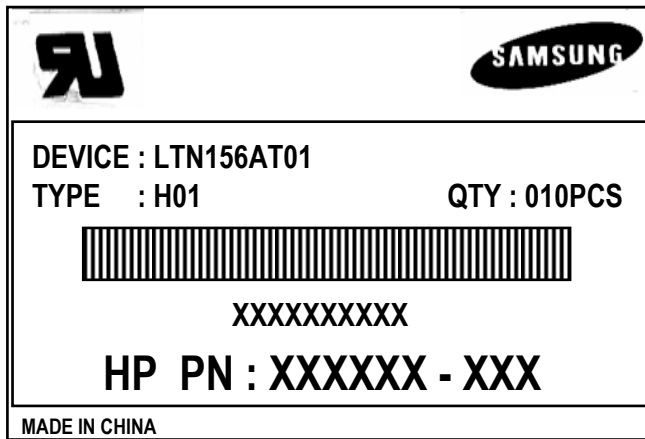

(7) Packing box Marking : Samsung TFT-LCD Brand Name



Samsung Secret

Doc.No.	LTN156AT01-H01	Rev.No	04-A00-0-081128	Page	25 / 30
----------------	----------------	---------------	-----------------	-------------	---------

Approval

10. GENERAL PRECAUTIONS

1. Handling

- (a) When the module is assembled, It should be attached to the system firmly using every mounting holes. Be careful not to twist and bend the modules.
- (b) Refrain from strong mechanical shock and / or any force to the module. In addition to damage, this may cause improper operation or damage to the module and CCFT back-light.
- (c) Note that polarizers are very fragile and could be easily damaged. Do not press or scratch the surface harder than a HB pencil lead.
- (d) Wipe off water droplets or oil immediately. If you leave the droplets for a long time, Staining and discoloration may occur.
- (e) If the surface of the polarizer is dirty, clean it using some absorbent cotton or soft cloth.
- (f) The desirable cleaners are water, IPA (Isoprophyl Alcohol) or Hexane. Do not use Ketone type materials(ex. Acetone), Ethyl alcohol, Toluene, Ethyl acid or Methyl chloride. It might permanent damage to the polarizer due to chemical reaction.
- (g) If the liquid crystal material leaks from the panel, it should be kept away from the eyes or mouth . In case of contact with hands, legs or clothes, it must be washed away thoroughly with soap.
- (h) Protect the module from static , it may cause damage to the C-MOS Gate Array IC.
- (i) Use fingerstalls with soft gloves in order to keep display clean during the incoming inspection and assembly process.
- (j) Do not disassemble the module.
- (k) Do not pull or fold the lamp wire.
- (l) Do not adjust the variable resistor which is located on the back side.
- (m) Protection film for polarizer on the module shall be slowly peeled off just before use so that the electrostatic charge can be minimized.
- (n) Pins of I/F connector shall not be touched directly with bare hands.

Samsung Secret

Doc.No.	LTN156AT01-H01	Rev.No	04-A00-0-081128	Page	26 / 30
----------------	----------------	---------------	-----------------	-------------	---------

Approval

2. STORAGE

- (a) Do not leave the module in high temperature, and high humidity for a long time. It is highly recommended to store the module with temperature from 0 to 35 °C and relative humidity of less than 70%.
- (b) Do not store the TFT-LCD module in direct sunlight.
- (c) The module shall be stored in a dark place. It is prohibited to apply sunlight or fluorescent light during the store.

3. OPERATION

- (a) Do not connect,disconnect the module in the " Power On" condition.
- (b) Power supply should always be turned on/off by following item 6.3 " Power on/off sequence ".
- (c) Module has high frequency circuits. Sufficient suppression to the electromagnetic interference shall be done by system manufacturers. Grounding and shielding methods may be important to minimize the interference.
- (d) The standard limited warranty is only applicable when the module is used for general notebook applications. If used for purposes other than as specified, SEC is not to be held reliable for the defective operations. It is strongly recommended to contact SEC to find out fitness for a particular purpose.

4. OTHERS

- (a) Ultra-violet ray filter is necessary for outdoor operation.
- (b) Avoid condensation of water. It may result in improper operation or disconnection of electrode.
- (c) Do not exceed the absolute maximum rating value. (the supply voltage variation, input voltage variation, variation in part contents and environmental temperature, so on) Otherwise the module may be damaged.
- (d) If the module displays the same pattern continuously for a long period of time,it can be the situation when the image "sticks" to the screen.
- (e) This module has its circuitry PCB's on the rear side and should be handled carefully in order not to be stressed.

Samsung Secret

Doc.No.	LTN156AT01-H01	Rev.No	04-A00-0-081128	Page	27 / 30
----------------	----------------	---------------	-----------------	-------------	---------

11. EDID

Approval

Address (HEX)	FUNCTION	Value	BIN	DEC	ASCII or Data	Notes
		HEX				
00	Header	00	00000000	0		EDID Header
01		FF	11111111	255		
02		FF	11111111	255		
03		FF	11111111	255		
04		FF	11111111	255		
05		FF	11111111	255		
06		FF	11111111	255		
07		00	00000000	0		
08	ID Manufacturer Name	4C	01001100	76	S	3 character ID
09		A3	10100011	163	E C	"SEC"
0A	ID Product Code	51	01010001	81	[Q]	
0B		34	00110100	52	[4]	
0C	32-bit serial no.	00	00000000	0		
0D		00	00000000	0		
0E		00	00000000	0		
0F		00	00000000	0		
10	Week of manufacture	00	00000000	0		
11	Year of manufacture	12	00010010	18	2008	2008
12	EDID Structure Ver.	01	00000001	1	1	EDID Ver. 1.0
13	EDID revision #	03	00000011	3	3	EDID Rev. 3
14	Video input definition	80	10000000	128		
15	Max H image size	22	00100010	34	34	34 cm(approx)
16	Max V image size	13	00010011	19	19	19 cm(approx)
17	Display Gamma	78	01111000	120	2.2	Gamma 2.2
18	Feature support	0A	00001010	10		
19	Red/green low bits	87	10000111	135		10000111
1A	Blue/white low bits	F5	11110101	245		11111110
1B	Red x/ high bits	94	10010100	148	0.580	Red x0.580= 1001010010
1C	Red y	57	01010111	87	0.340	Red y0.340= 0101011100
1D	Green x	4F	01001111	79	0.310	Green x0.310= 0100111101
1E	Green y	8C	10001100	140	0.550	Green y0.550= 1000110011
1F	Blue x	27	00100111	39	0.155	Blue x0.155= 0010011111
20	Blue y	27	00100111	39	0.155	Blue y0.155= 0010011111
21	White x	50	01010000	80	0.313	White x0.313= 0101000001
22	White y	54	01010100	84	0.329	White y0.329= 0101010001
23	Established timing 1	00	00000000	0		
24	Established timing 2	00	00000000	0		
25	Established timing 3	00	00000000	0		

Samsung Secret

Approval

26	Standard timing #1	01	00000001	1		not used	
27		01	00000001	1			
28	Standard timing #2	01	00000001	1		not used	
29		01	00000001	1			
2A	Standard timing #3	01	00000001	1		not used	
2B		01	00000001	1			
2C	Standard timing #4	01	00000001	1		not used	
2D		01	00000001	1			
2E	Standard timing #5	01	00000001	1		not used	
2F		01	00000001	1			
30	Standard timing #6	01	00000001	1		not used	
31		01	00000001	1			
32	Standard timing #7	01	00000001	1		not used	
33		01	00000001	1			
34	Standard timing #8	01	00000001	1		not used	
35		01	00000001	1			
36	Detailed timing/monitor descriptor #1	12	00010010	18	69.3	Main clock= 69.3 MHz	
37		1B	00011011	27			
38		56	01010110	86	1366	Hor active=1366 pixels	
39		72	01110010	114	114	Hor blanking=114 pixels	
3A		50	01010000	80		4bit : 4bit	
3B		00	00000000	0	768	Vertical active=768 lines	
3C		0C	00001100	12	12	Vertical blanking=12 lines	
3D		30	00110000	48		4bit : 4bit	
3E		30	00110000	48	48	H sync. Offset=48 pixels	
3F		20	00100000	32	32	H sync. Width=32 pixels	
40			25	00100101	37	2	V sync. Offset=2 lines
						5	V sync. Width=5 lines
41			00	00000000	0		2bit : 2bit :2bit :2bit
42			58	01011000	88	344	H image size= 344 mm(approx)
43			C2	11000010	194	194	V image size = 194 mm(approx)
44			10	00010000	16		
45			00	00000000	0		No Horizontal Border
46			00	00000000	0		No Vertical Border
47			19	00011001	25		
48		Detailed timing/monitor descriptor #2	00	00000000	0		Manufacturer Specified (Timing)
49	00		00000000	0			
4A	00		00000000	0			
4B	0F		00001111	15			
4C	00		00000000	0		Value=HSPWmin / 2	
4D	00		00000000	0		Value=HSPWmax / 2	
4E	00		00000000	0		Value=Thbpmin / 2	
4F	00		00000000	0		Value=Thbpmax / 2	
50	00		00000000	0		Value=VSPWmin / 2	
51	00		00000000	0		Value=VSPWmax / 2	
52	00		00000000	0		Value=TVbpmin / 2	
53	00		00000000	0		Value=TVbpmax / 2	
54	00		00000000	0		Value=TVbpmin / 2	
55	1E		00011110	30		Thpmin=value*2 + HA pixelclks	
56	B4		10110100	180		Thpmax=value*2 + HA pixelclks	
57	02		00000010	2		Tvpmin=value*2 + VA lines	
58	74		01110100	116		Tvpmax=value*2 + VA lines	
59	00	00000000	0		Module revision		

Samsung Secret

Approval

5A	Detailed timing/monitor descriptor #3	00	00000000	0		ASCII Data String Tag
5B		00	00000000	0		
5C		00	00000000	0		
5D		FE	11111110	254		
5E		00	00000000	0		
5F		53	01010011	83	[S]	
60		41	01000001	65	[A]	
61		4D	01001101	77	[M]	
62		53	01010011	83	[S]	
63		55	01010101	85	[U]	
64		4E	01001110	78	[N]	
65		47	01000111	71	[G]	
66		0A	00001010	10	[^]	
67		20	00100000	32	[]	
68	20	00100000	32	[]		
69	20	00100000	32	[]		
6A	20	00100000	32	[]		
6B	20	00100000	32	[]		
6C	Detailed timing/monitor descriptor #4	00	00000000	0		Monitor Name Tag (ASCII)
6D		00	00000000	0		
6E		00	00000000	0		
6F		FE	11111110	254		
70		00	00000000	0		
71		31	00110001	49	[1]	
72		35	00110101	53	[5]	
73		36	00110110	54	[6]	
74		41	01000001	65	[A]	
75		54	01010100	84	[T]	
76		30	00110000	48	[0]	
77		31	00110001	49	[1]	
78		2D	00101101	45	[-]	
79		48	01001000	72	[H]	
7A	30	00110000	48	[0]		
7B	31	00110001	49	[1]		
7C	0A	00001010	10	[^]		
7D	20	00100000	32	[]		
7E	Extension Flag	00	00000000	0		
7F	Checksum	1B	00011011	27		

Samsung Secret