

# SPECIFICATION FOR APPROVAL

( ) Preliminary Specification

( ◆ ) Final Specification

Title	15.6" HD TFT LCD
-------	------------------

Customer	
MODEL	

SUPPLIER	LG Display Co., Ltd.
*MODEL	LP156WHU
Suffix	TPA1

\*When you obtain standard approval,  
please use the above model name without suffix

APPROVED BY	SIGNATURE
/	_____
/	_____
/	_____

APPROVED BY	SIGNATURE
J. Y.Lee / G.Manager	_____
REVIEWED BY	
J. S. Park / Manager	_____
PREPARED BY	
K. T. Baek / Engineer	
C. Y. Jung / Engineer	_____

Please return 1 copy for your confirmation with your signature and comments.

**Products Engineering Dept.  
LG Display Co., Ltd**

## Product Specification

Contents

No	ITEM	Page
	COVER	1
	CONTENTS	2
	RECORD OF REVISIONS	3
1	GENERAL DESCRIPTION	4
2	ABSOLUTE MAXIMUM RATINGS	5
3	ELECTRICAL SPECIFICATIONS	
3-1	ELECTRICAL CHARACTREISTICS	6-7
3-2	INTERFACE CONNECTIONS	8
3-3	LVDS SIGNAL TIMING SPECIFICATION	9
3-4	SIGNAL TIMING SPECIFICATIONS	10
3-5	SIGNAL TIMING WAVEFORMS	10
3-6	COLOR INPUT DATA REFERNECE	11
3-7	POWER SEQUENCE	12
4	OPTICAL SFECIFICATIONS	13-15
5	MECHANICAL CHARACTERISTICS	16-18
A	APPENDIX. LGD PROPOSAL FOR SYSTEM COVER DESIGN	19-23
6	RELIABLITY	24
7	INTERNATIONAL STANDARDS	
7-1	SAFETY	25
7-2	EMC	25
7-3	Environment	25
8	PACKING	
8-1	DESIGNATION OF LOT MARK	26
8-2	PACKING FORM	26
9	PRECAUTIONS	27-28
A	APPENDIX. Enhanced Extended Display Identification Data	29-31

### RECORD OF REVISIONS

Revision No	Revision Date	Page	Description	EDID ver
0.0	Oct. 11. 2012	-	First Draft (Preliminary Specification)	-
	Oct. 23. 2012	20 ~ 24	Add LGD PROPOSAL FOR SYSTEM COVER DESIGN	
0.1	Jan. 10. 2013	6	Update Power Consumption	0.1
		12	Change Power Sequence	
		13	Update Color Coordinates	
		14	Update Gray Scale	
		29 ~ 31	Update EDID	
1.0	Apr. 02. 2013		Final Version	1.0

## 1. General Description

The LP156WHU is a Color Active Matrix Liquid Crystal Display with an integral LED backlight system. The matrix employs a-Si Thin Film Transistor as the active element. It is a transmissive type display operating in the normally black mode. This TFT-LCD has 15.6 inches diagonally measured active display area with HD resolution (1366 horizontal by 768 vertical pixel array). Each pixel is divided into Red, Green and Blue sub-pixels or dots which are arranged in vertical stripes. Gray scale or the brightness of the sub-pixel color is determined with a 6-bit gray scale signal for each dot, thus, presenting a palette of more than 262,144 colors. The LP156WHU has been designed to apply the interface method that enables low power, high speed, low EMI. The LP156WHU is intended to support applications where thin thickness, low power are critical factors and graphic displays are important. In combination with the vertical arrangement of the sub-pixels, the LP156WHU characteristics provide an excellent flat display for office automation products such as Notebook PC.

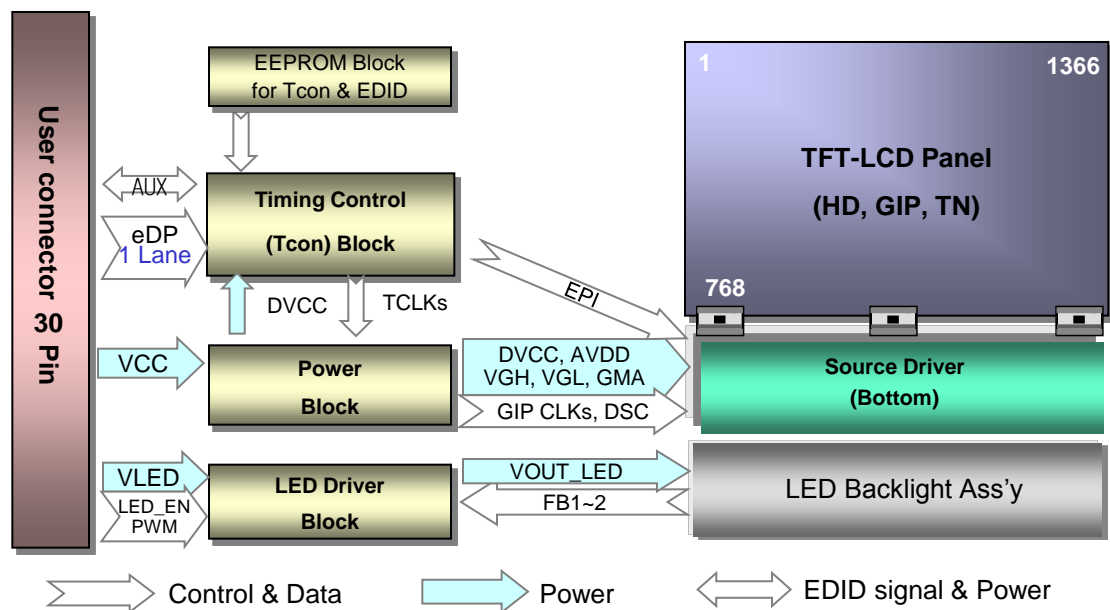

## General Features

Active Screen Size	15.6 inches diagonal
Outline Dimension	359.5(H, Typ.) × 217.2(V, Typ.) × 3.2(D, Max.) [mm] (with PCB Board)
Pixel Pitch	0.252mm X 0.252 mm
Pixel Format	1366 horiz. by 768 vert. Pixels RGB strip arrangement
Color Depth	6-bit, 262,144 colors
Luminance, White	200 cd/m <sup>2</sup> (Typ.)
Power Consumption	Total 3.1 W(Typ.) Logic : 0.7 W (Typ. @ Mosaic), B/L : 2.4 W (Typ. @ VLED12V)
Weight	370g (Max.)
Display Operating Mode	Transmissive mode, normally white
Surface Treatment	Glare treatment (3H) of the front Polarizer
RoHS Compliance	Yes
BFR / PVC / As Free	Yes for all

## 2. Absolute Maximum Ratings

The following are maximum values which, if exceeded, may cause faulty operation or damage to the unit.

**Table 1. ABSOLUTE MAXIMUM RATINGS**

Parameter	Symbol	Values		Units	Notes
		Min	Max		
Power Input Voltage	VCC	-0.3	4.0	Vdc	at 25 ± 5°C
Operating Temperature	TOP	0	50	°C	1
Storage Temperature	HST	-20	60	°C	1
Operating Ambient Humidity	HoP	10	90	%RH	1
Storage Humidity	HST	10	90	%RH	1

Note : 1. Temperature and relative humidity range are shown in the figure below.  
Wet bulb temperature should be 39°C Max, and no condensation of water.

Note : 2. Storage Condition is guaranteed under packing condition.

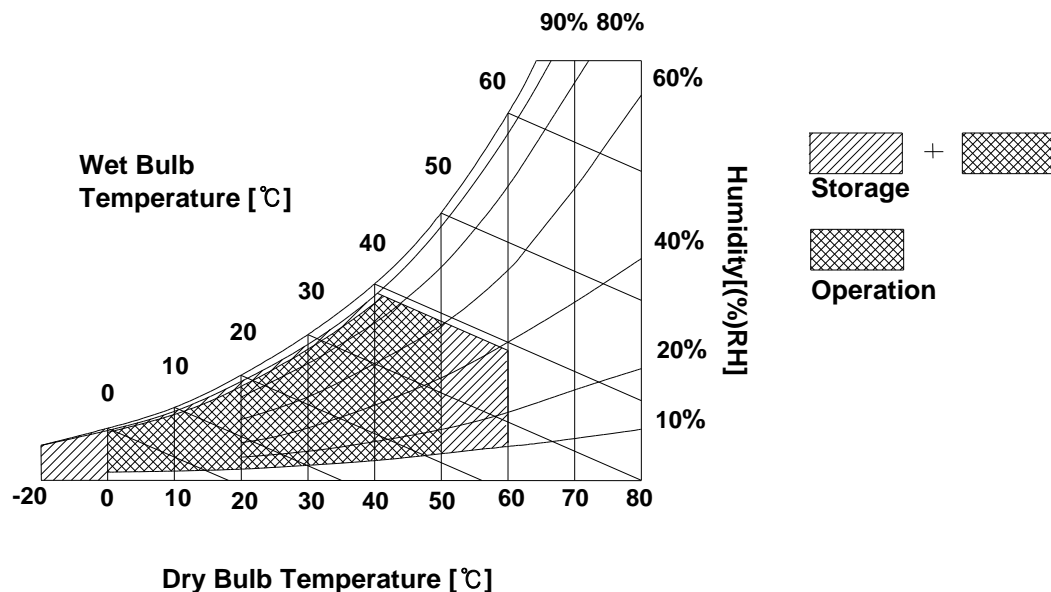

## Product Specification

### 3. Electrical Specifications

#### 3-1. Electrical Characteristics

The LP156WHU requires two power inputs. The first logic is employed to power the LCD electronics and to drive the TFT array and liquid crystal. The second backlight is the input about LED BL with LED Driver.

**Table 2. ELECTRICAL CHARACTERISTICS**

Parameter	Symbol	Values			Unit	Notes
		Min	Typ	Max		
LOGIC :						
Power Supply Input Voltage	V <sub>CC</sub>	3.0	3.3	3.6	V	1
Power Supply Input Current	I <sub>CC</sub>	-	220	255	mA	2
Power Consumption	P <sub>CC</sub>	-	0.7	0.8	W	2
Power Supply Inrush Current	I <sub>CC_P</sub>	-	-	1500	mA	3
Differential Impedance	Z <sub>m</sub>	90	100	110	Ω	4
BACKLIGHT : ( with LED Driver)						
LED Power Input Voltage	V <sub>LED</sub>	7.0	12.0	21.0	V	5
LED Power Input Current	I <sub>LED</sub>	-	200	220	mA	6
LED Power Consumption	P <sub>LED</sub>	-	2.4	2.6	W	6
LED Power Inrush Current	I <sub>LED_P</sub>	-	-	2000	mA	7
PWM Duty Ratio		5	-	100	%	8
PWM Jitter	-	0	-	0.2	%	9
PWM Impedance	Z <sub>PWM</sub>	20	40	60	kΩ	
PWM Frequency	F <sub>PWM</sub>	200	-	1000	Hz	10
PWM High Level Voltage	V <sub>PWM_H</sub>	3.0	-	3.6	V	
PWM Low Level Voltage	V <sub>PWM_L</sub>	0	-	0.3	V	
LED_EN Impedance	Z <sub>PWM</sub>	20	40	60	kΩ	
LED_EN High Voltage	V <sub>LED_EN_H</sub>	3.0	-	3.6	V	
LED_EN Low Voltage	V <sub>LED_EN_L</sub>	0	-	0.3	V	
Life Time		12,000	-	-	Hrs	11

Product Specification

Note)

1. The measuring position is the connector of LCM and the test conditions are under 25 °C , fv = 60Hz, Black pattern.
2. The specified Icc current and power consumption are under the Vcc = 3.3V , 25 °C , fv = 60Hz condition and Mosaic pattern.

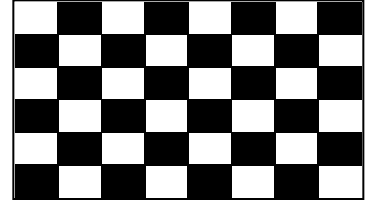

2. This Spec. is the max load condition for the cable impedance designing.
3. The below figures are the measuring Vcc condition and the Vcc control block LGD used.  
The Vcc condition is same as the minimum of T1 at Power on sequence.

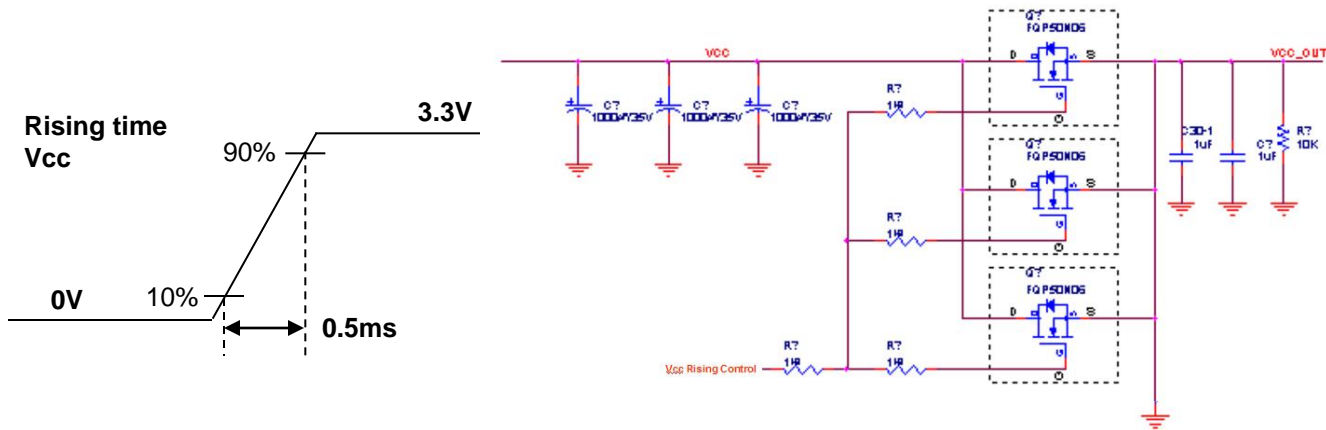

4. This impedance value is needed for proper display and measured form eDP Tx to the mating connector.
5. The measuring position is the connector of LCM and the test conditions are under 25 °C .
6. The current and power consumption with LED Driver are under the Vled = 12.0V , 25 °C , Dimming of Max luminance and White pattern with the normal frame frequency operated(60Hz).
7. The below figures are the measuring Vled condition and the Vled control block LGD used.  
VLED control block is same with Vcc control block.

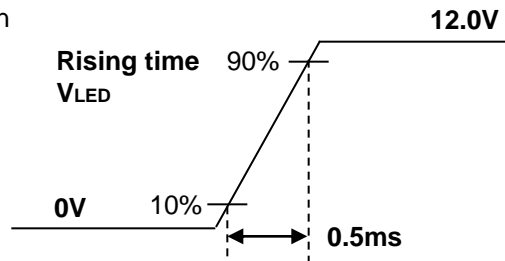

8. The operation of LED Driver below minimum dimming ratio may cause flickering or reliability issue.
9. If Jitter of PWM is bigger than maximum, it may induce flickering.
10. This Spec. is not effective at 100% dimming ratio as an exception because it has DC level equivalent to 0Hz. In spite of acceptable range as defined, the PWM Frequency should be fixed and stable for more consistent brightness control at any specific level desired.
11. The life time is determined as the time at which brightness of LCD is 50% compare to that of minimum value specified in table 7. under general user condition.

## Product Specification

### 3-2. Interface Connections

This LCD employs two interface connections, a 30 pin connector used for the module electronics interface and the other connector used for the integral backlight system.

**Table 3. MODULE CONNECTOR PIN CONFIGURATION (CN1)**

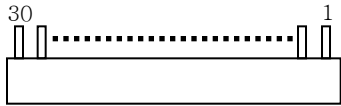
Pin	Symbol	Description	Notes
1	NC	NO Connect	<b>[Interface Chip]</b> 1. LCD : SW0661A (LCD Controller Including eDP Receiver. 2. System : STDP4028 or equivalent * Pin to Pin compatible with eDP  <b>[Connector]</b> KN38-30S-0.5H or equivalent  <b>[Connector pin arrangement]</b>  [LCD Module Rear View]  <b>[LGD Pvcom pin]</b> 1. Pin for P-Vcom : #24, #25 2. P-Vcom Address : 01010000
2	GND	High Speed (Main Link) Ground	
3	NC	NO Connect	
4	NC	NO Connect	
5	GND	High Speed (Main Link) Ground	
6	Lane0_N	Complement Signal-Lane 0	
7	Lane0_p	True Signal-Main Lane 0	
8	GND	High Speed (Main Link) Ground	
9	AUX_P	True Signal-Auxiliary Channel	
10	AUX_N	Complement Signal-Auxiliary Channel	
11	GND	High Speed (Main Link) Ground	
12	VCC	LCD Logic and driver power (3.3V Typ.)	
13	VCC	LCD Logic and driver power (3.3V Typ.)	
14	NC	NO Connect	
15	GND	Ground	
16	GND	Ground	
17	HPD	HPD signal pin	
18	GND	LED Backlight Ground	
19	GND	LED Backlight Ground	
20	GND	LED Backlight Ground	
21	GND	LED Backlight Ground	
22	LED_EN	LED Backlight On/Off	
23	PWM	System PWM Signal input for dimming	
24	Clk EEDID	DDC Clock (LGD P-Vcom Share Pin)	
25	DATA EEDID	DDC Data (LGD P-Vcom Share Pin)	
26	VLED	LED Backlight Power (7.0V-21V)	
27	VLED	LED Backlight Power (7.0V-21V)	
28	VLED	LED Backlight Power (7.0V-21V)	
29	VLED	LED Backlight Power (7.0V-21V)	
30	NC	NO Connect	



### 3-3. eDP Signal Timing Specifications

#### 3-3-1. DC Specification

The VESA Display Port related AC specification is compliant with the VESA Display Port Standard.

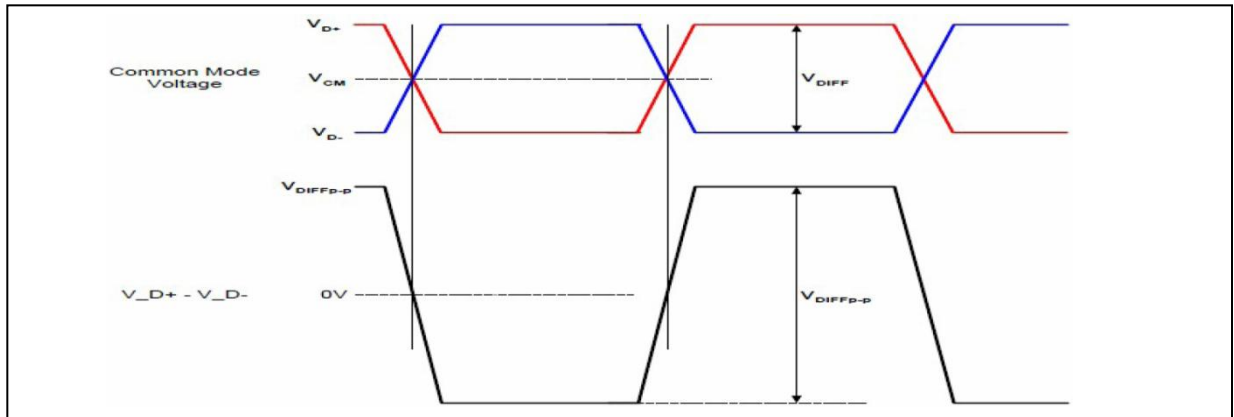

Description	Symbol	Min	Max	Unit	Notes
Differential peak-to-peak Input voltage	$V_{DIFF\ p-p}$	120	-	mV	For high bit rate
		40	-		For reduced bit rate
Rx DC common mode voltage	$V_{CM}$	0	2.0	V	-

#### 3-3-2. AC Specification

The VESA Display Port related AC specification is compliant with the VESA Display Port Standard.

Description	Symbol	Min	Typ	Max	Unit	Notes
Unit Interval for high bit rate (2.7Gbps/lane)	UI_High_Rate	-	370	-	ps	Range is nominal $\pm 350$ ppm. DisplayPort Link Rx does not require local crystal for link clock generation
Unit Interval for high bit rate (1.62Gbps/lane)	UI_Low_Rate	-	617	-	ps	
Link Clock Down Spreading	Down_Spread_Amplitude	0	-	0.5	%	-
Lane-to-Lane skew	V Rx-SKEW-INTER_PAIR	-	-	5200	ps	-
Lane intra-pair skew	V Rx-SKEW-INTRA_PAIR	-	-	100	ps	For high bit rate
		-	-	300	ps	For reduced bit rate

### 3-4. Signal Timing Specifications

This is the signal timing required at the input of the User connector. All of the interface signal timing should be satisfied with the following specifications and specifications of eDP Tx/Rx for its proper operation.

**Table 4. TIMING TABLE**

ITEM	Symbol	Min	Typ	Max	Unit	Note
DCLK	Frequency	$f_{CLK}$	-	76.3	-	MHz
Hsync	Period	$t_{HP}$	1586	1610	1634	tCLK
	Width	$t_{WH}$	24	32	40	
	Width-Active	$t_{WHA}$	1366	1366	1366	
Vsync	Period	$t_{VP}$	788	790	796	tHP
	Width	$t_{WV}$	4	5	6	
	Width-Active	$t_{WVA}$	768	768	768	
Data Enable	Horizontal back porch	$t_{HBP}$	172	180	188	tCLK
	Horizontal front porch	$t_{HFP}$	24	32	40	
	Vertical back porch	$t_{VBP}$	14	14	18	tHP
	Vertical front porch	$t_{VFP}$	2	3	4	

**Appendix** all reliabilities are specified for timing specification based on refresh rate of 60Hz. However, LP156WHU has a good actual performance even at lower refresh rate (e.g. 40Hz or 50Hz) for power saving mode, whereas LP156WHU is secured only for function under lower refresh rate. 60Hz at Normal mode, 50Hz, 40Hz at Power save mode. Don't care Flicker level (power save mode).

### 3-5. Signal Timing Waveforms

Condition : VCC = 3.3V

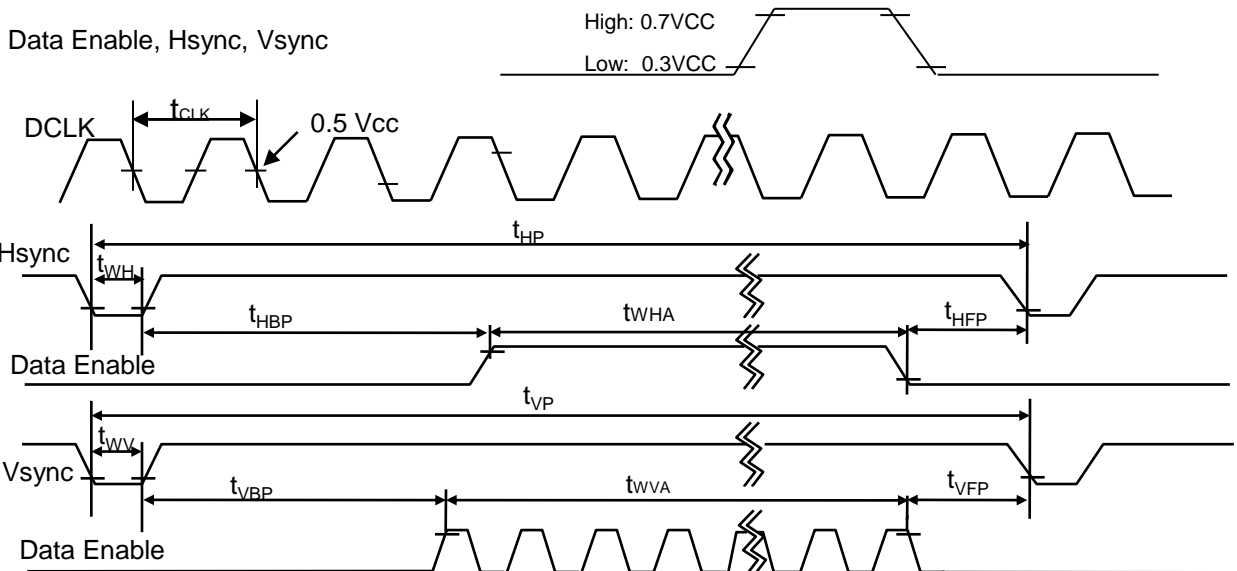

## Product Specification

**3-6. Color Input Data Reference**

The brightness of each primary color (red, green and blue) is based on the 6-bit gray scale data input for the color ; the higher the binary input, the brighter the color. The table below provides a reference for color versus data input.

**Table 5. COLOR DATA REFERENCE**

Color		Input Color Data																					
		RED						GREEN						BLUE									
		MSB						LSB		MSB						LSB		MSB					
		R5	R4	R3	R2	R1	R0	G5	G4	G3	G2	G1	G0	B5	B4	B3	B2	B1	B0				
Basic Color	Black	0	0	0	0	0	0	0	0	0	0	0	0	0	0	0	0	0	0				
	Red	1	1	1	1	1	1	0	0	0	0	0	0	0	0	0	0	0	0				
	Green	0	0	0	0	0	0	1	1	1	1	1	1	0	0	0	0	0	0				
	Blue	0	0	0	0	0	0	0	0	0	0	0	0	1	1	1	1	1	1				
	Cyan	0	0	0	0	0	0	1	1	1	1	1	1	1	1	1	1	1	1				
	Magenta	1	1	1	1	1	1	0	0	0	0	0	0	1	1	1	1	1	1				
	Yellow	1	1	1	1	1	1	1	1	1	1	1	1	0	0	0	0	0	0				
	White	1	1	1	1	1	1	1	1	1	1	1	1	1	1	1	1	1	1				
RED	RED (00)	0	0	0	0	0	0	0	0	0	0	0	0	0	0	0	0	0	0				
	RED (01)	0	0	0	0	0	1	0	0	0	0	0	0	0	0	0	0	0	0				
	...	...						...						...									
	RED (62)	1	1	1	1	1	0	0	0	0	0	0	0	0	0	0	0	0	0				
	RED (63)	1	1	1	1	1	1	0	0	0	0	0	0	0	0	0	0	0	0				
GREEN	GREEN (00)	0	0	0	0	0	0	0	0	0	0	0	0	0	0	0	0	0	0				
	GREEN (01)	0	0	0	0	0	0	0	0	0	0	0	1	0	0	0	0	0	0				
	...	...						...						...									
	GREEN (62)	0	0	0	0	0	0	1	1	1	1	1	0	0	0	0	0	0	0				
	GREEN (63)	0	0	0	0	0	0	1	1	1	1	1	1	0	0	0	0	0	0				
BLUE	BLUE (00)	0	0	0	0	0	0	0	0	0	0	0	0	0	0	0	0	0	0				
	BLUE (01)	0	0	0	0	0	0	0	0	0	0	0	0	0	0	0	0	0	1				
	...	...						...						...									
	BLUE (62)	0	0	0	0	0	0	0	0	0	0	0	0	1	1	1	1	1	0				
	BLUE (63)	0	0	0	0	0	0	0	0	0	0	0	0	1	1	1	1	1	1				

Product Specification

3-7. Power Sequence

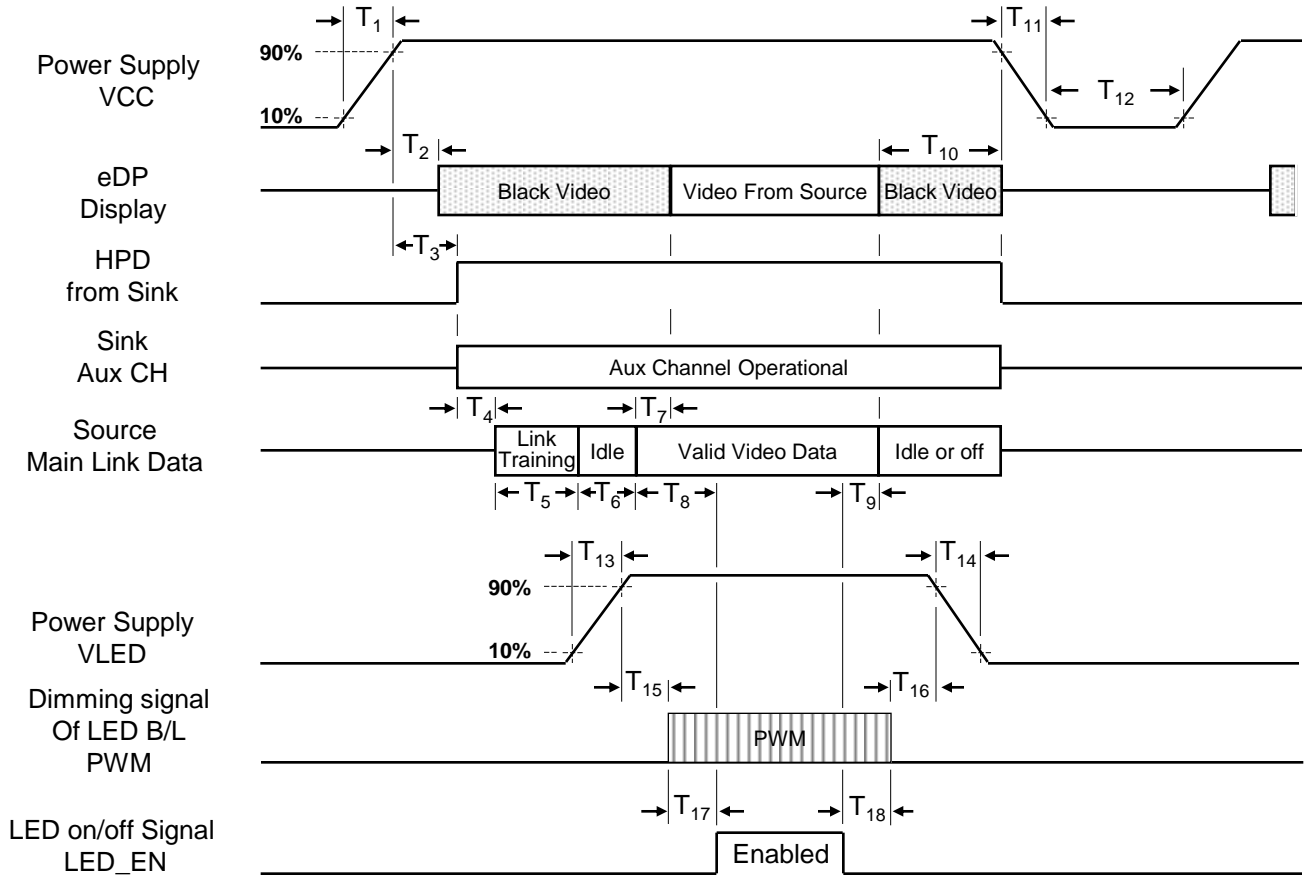

Table 6. POWER SEQUENCE TABLE

Timing	Required By	Limits		Units	Notes
		Min	Max		
T <sub>1</sub>	Source	0.5	10	ms	-
T <sub>2</sub>	Sink	0	200	ms	-
T <sub>3</sub>	Sink	0	200	ms	-
T <sub>4</sub>	Source	-	-	ms	-
T <sub>5</sub>	Source	-	-	ms	-
T <sub>6</sub>	Source	-	-	ms	-
T <sub>7</sub>	Sink	0	50	ms	-
T <sub>8</sub>	Source	-	-	ms	LGD recommend Min 200ms
T <sub>9</sub>	Source	-	-	ms	-

Timing	Required By	Limits		Units	Notes
		Min	Max		
T <sub>10</sub>	Source	0	500	ms	-
T <sub>11</sub>	Source	-	10	ms	-
T <sub>12</sub>	Source	500	-	ms	-
T <sub>13</sub>	Source	0.5	10	ms	-
T <sub>14</sub>	Source	0.5	10	ms	-
T <sub>15</sub>	Source	10	-	ms	-
T <sub>16</sub>	Source	10	-	ms	-
T <sub>17</sub>	Source	0	-	ms	-
T <sub>18</sub>	Source	0	-	ms	-

- Note) 1. Do not insert the mating cable when system turn on.  
 2. Valid Data have to meet "3-3. eDP Signal Timing Specifications"  
 3. Video Signal, LED\_EN and PWM need to be on pull-down condition on invalid status.  
 4. LGD recommend the rising sequence of VLED after the Vcc and valid status of Video Signal turn on.

## 4. Optical Specification

Optical characteristics are determined after the unit has been 'ON' and stable for approximately 30 minutes in a dark environment at 25°C. The values specified are at an approximate distance 50cm from the LCD surface at a viewing angle of  $\Phi$  and  $\Theta$  equal to 0°.

FIG. 1 presents additional information concerning the measurement equipment and method.

**FIG. 1 Optical Characteristic Measurement Equipment and Method**

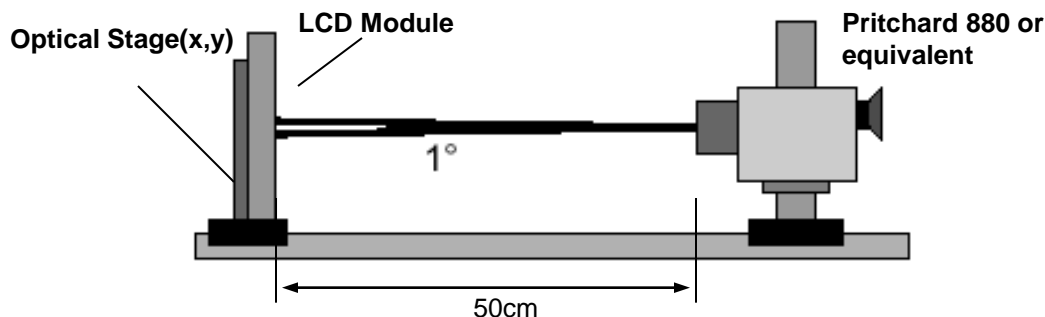

**Table 9. OPTICAL CHARACTERISTICS**

$T_a=25^{\circ}\text{C}$ ,  $V_{CC}=3.3\text{V}$ ,  $f_v=60\text{Hz}$ ,  $f_{CLK}=76.3\text{MHz}$

Parameter	Symbol	Values			Units	Notes
		Min	Typ	Max		
Contrast Ratio	CR	400	500	-		1
Surface Luminance, white	$L_{WH}$	170	200	-	cd/m <sup>2</sup>	2
Luminance Variation	$\delta_{WHITE}$	-	1.4	1.6		3
Response Time	$T_{R+T_D}$	-	16	25	ms	4
Color Coordinates						
RED	RX	0.548	0.578	0.608		
	RY	0.314	0.344	0.374		
GREEN	GX	0.307	0.337	0.367		
	GY	0.541	0.571	0.601		
BLUE	BX	0.129	0.159	0.189		
	BY	0.090	0.120	0.150		
WHITE	WX	0.283	0.313	0.343		
	WY	0.299	0.329	0.359		
Viewing Angle						
x axis, right( $\Phi=0^{\circ}$ )	$\Theta_r$	40	-	-	degree	5
x axis, left ( $\Phi=180^{\circ}$ )	$\Theta_l$	40	-	-	degree	
y axis, up ( $\Phi=90^{\circ}$ )	$\Theta_u$	10	-	-	degree	
y axis, down ( $\Phi=270^{\circ}$ )	$\Theta_d$	30	-	-	degree	
Gray Scale						6

## Product Specification

Note)

1. Contrast Ratio(CR) is defined mathematically as

$$\text{Contrast Ratio} = \frac{\text{Surface Luminance with all white pixels}}{\text{Surface Luminance with all black pixels}}$$

2. Surface luminance is the average of 5 point across the LCD surface 50cm from the surface with all pixels displaying white. For more information see FIG 1.

$$\text{LWH} = \text{Average}(\text{L1}, \text{L2}, \dots \text{L5})$$

 3. The variation in surface luminance , The panel total variation ( $\delta$  WHITE) is determined by measuring LN at each test position 1 through 13 and then defined as following numerical formula.  
 For more information see FIG 2.

$$\delta \text{ WHITE (13P)} = \frac{\text{Maximum (L1,L2, ... L13)}}{\text{Minimum (L1,L2, ... L13)}} \quad \delta \text{ WHITE (5P)} = \frac{\text{Maximum(L1,L2, ... L5)}}{\text{Minimum(L1,L2, ... L5)}}$$

4. Response time is the time required for the display to transition from white to black (rise time, TrR) and from black to white(Decay Time, TrD). For additional information see FIG 3.

5. Viewing angle is the angle at which the contrast ratio is greater than 10. The angles are determined for the horizontal or x axis and the vertical or y axis with respect to the z axis which is normal to the LCD surface. For more information see FIG 4.

6. Gray scale specification

\* fV = 60Hz

Gray Level	Luminance [%] (Typ)
L0	0.15
L7	1.24
L15	4.97
L23	11.4
L31	20.6
L39	34.4
L47	53.0
L55	75.7
L63	100

Product Specification

**FIG. 2 Luminance**

<Measuring point for Average Luminance & measuring point for Luminance variation>

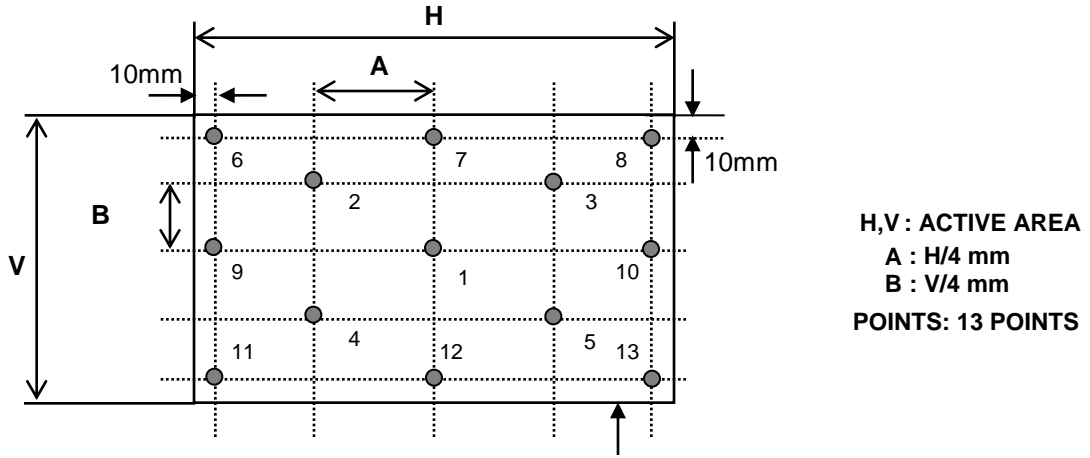

**FIG. 3 Response Time**

Active Area

The response time is defined as the following figure and shall be measured by switching the input signal for “black” and “white”.

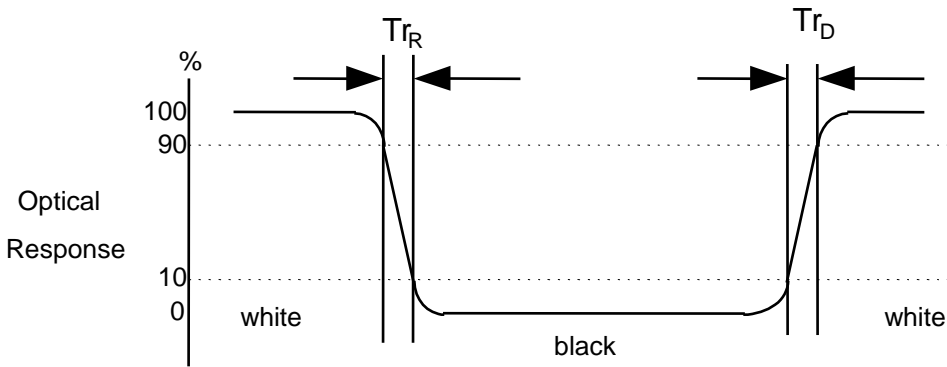

**FIG. 4 Viewing angle**

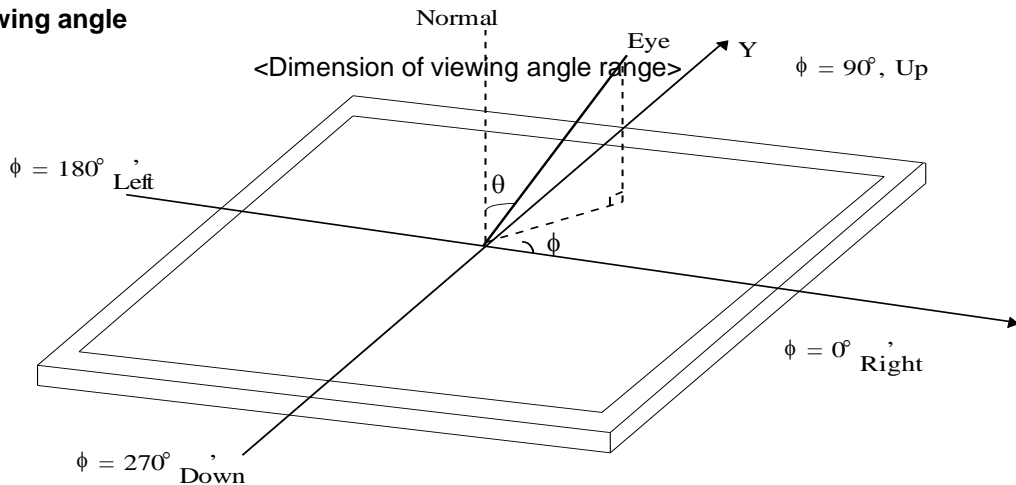

## Product Specification

## 5. Mechanical Characteristics

The contents provide general mechanical characteristics for the model LP156WH3. In addition the figures in the next page are detailed mechanical drawing of the LCD.

Outline Dimension	Horizontal	359.5 ± 0.5mm
	Vertical	217.2 ± 0.5mm
	Thickness	3.2mm (max)
Bezel Area	Horizontal	347.5 ± 0.5mm
	Vertical	196.8 ± 0.5mm
Active Display Area	Horizontal	344.23 mm
	Vertical	193.54 mm
Weight	370g (Max.)	
Surface Treatment	Hard Coating(3H), Glare treatment of the front polarizer	





Product Specification

<REAR VIEW>

Note) Unit:[mm], General tolerance:  $\pm 0.5\text{mm}$

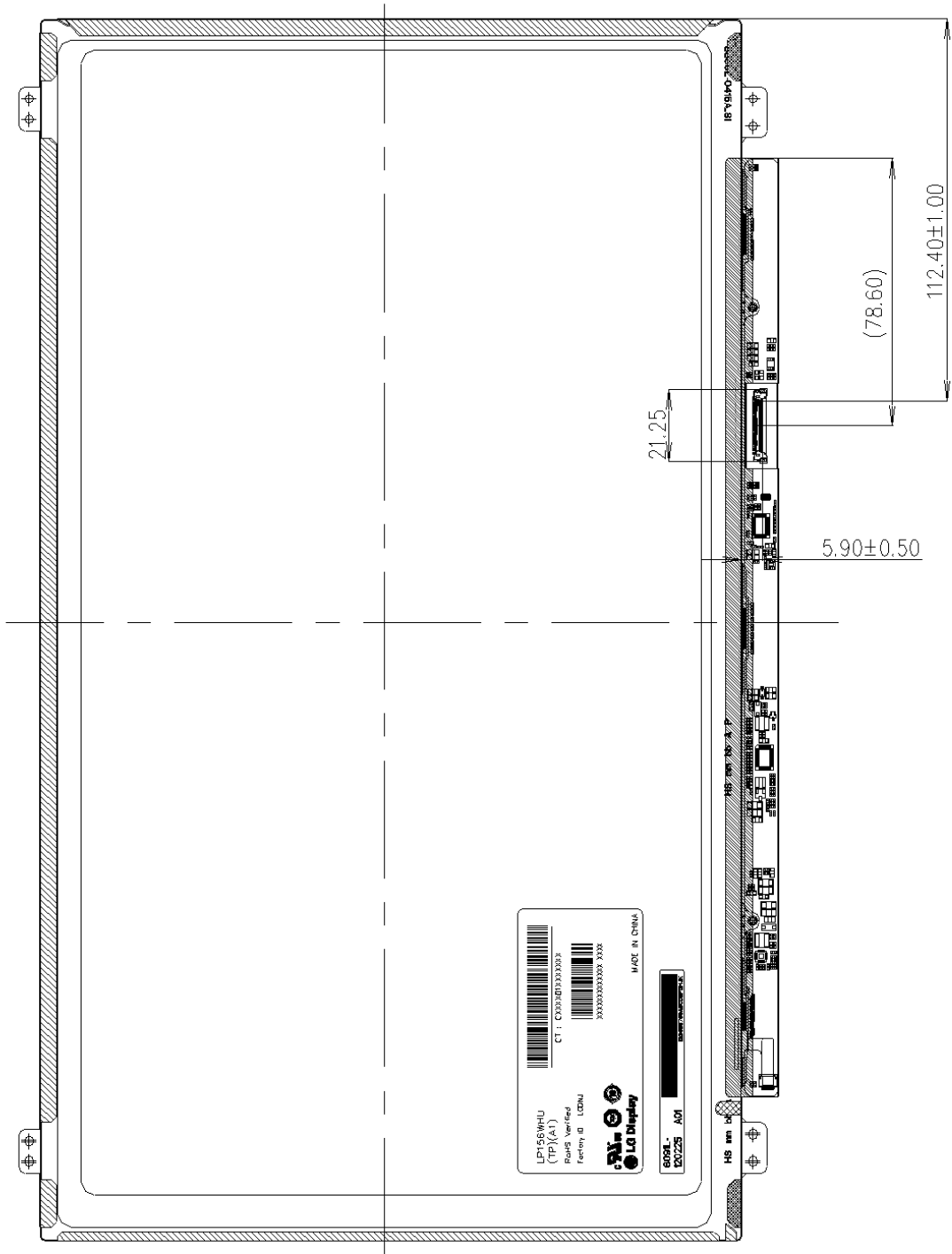

**LGD Proposal for system cover design.(Appendix)**

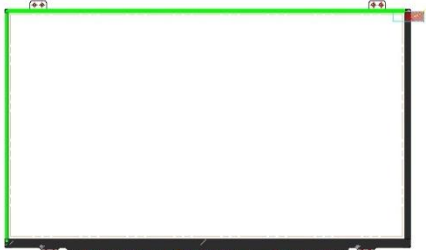
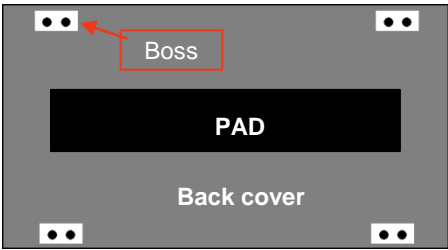
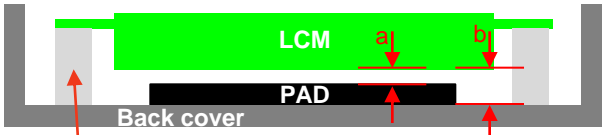
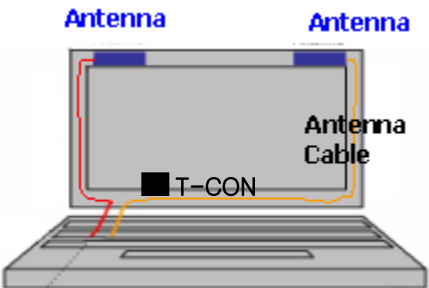
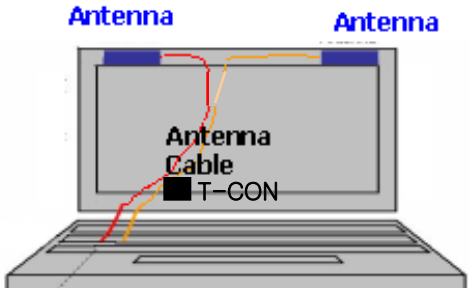
<p>1</p>	<p><b>Gap check for securing the enough gap between LCM and System back cover.</b></p>
<div style="display: flex; justify-content: space-around;"> <div style="text-align: center;">  <p>+</p>  </div> <div style="text-align: center;">  <p>LCM PAD Back cover Boss</p> <p>◆ a : min 0mm ◆ b : min 0.3mm, Max 1.0mm</p> </div> </div>	
<p>Define</p>	<p>1.Rear side of LCM is sensitive against external stress, and previous check about interference is highly needed.</p> <p>2.In case there is something from system cover comes into the boundary above,mechanical interference may cause the FOS defects. (Eg: Ripple, White spot..)</p>
<p>2</p>	<p><b>Check if antenna cable is sufficiently apart from T-CON of LCD Module.</b></p>
<div style="display: flex; justify-content: space-around;"> <div style="text-align: center;">  <p>Antenna Antenna Antenna Cable T-CON OK</p> </div> <div style="text-align: center;">  <p>Antenna Antenna Antenna Cable T-CON NG</p> </div> </div>	
<p>Define</p>	<p>1.If system antenna is overlapped with T-CON,it might be cause the noise</p>

**LGD Proposal for system cover design.(Appendix)**

<p><b>3</b></p>	<p><b>Checking the path of the System wire</b></p>
<p>Define</p>	<p>1.If Wire path overlapped with LCM, it is happened white spot, COF problem, etc.</p> <p>2.OK → Wire path design to system side. NG → Wire path overlapped with LCM.</p>
<p><b>4</b></p>	<p><b>Add pad to Prevent panel crack against external load (push)</b></p>
<p>Define</p>	<p>1. At flat type LCM, panel is easily cracked at flange area during push, assemble.</p> <p>2. Add pad, it prevent panel crack</p>









**LGD Proposal for system cover design.(Appendix)**

5	Check the rib or Bracket on back cover
Define	<p>1.It is necessary that the height of back cover rib or bracket is higher than LCM height. It can prevent direct compression of panel at LCM edge.</p> <p>2."┌" shape bracket is stronger than "I" shape one.</p>
6	Check the gap between front cover and LCM(glass)
<div data-bbox="271 1526 821 1671" style="background-color: #c8e6c9; padding: 10px; margin-top: 10px;"> <p>[OK] <math>a \geq 0.3\text{mm}</math>              [CO] <math>0.3\text{mm} \geq a \geq 0.1\text{mm}</math>              [NG] <math>a \leq 0.1\text{mm}</math></p> </div>	
Define	1. Ripple can be happened by little gap between glass and front cover.

**LGD Proposal for system cover design.(Appendix)**

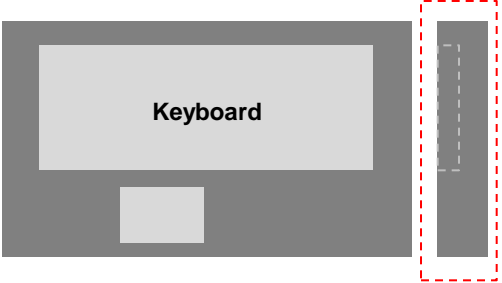
7	<b>Check the rib or Bracket on back cover</b>
Define	1.If it is possible, shrink to apply front cover of white color. ..... 2. White color can caused light leakage
8	<b>Check the wire position(path)</b>
Define	1. It is necessary that wire is posited out of hook, not posited near hook,..... 2. If wire is posited near hook, it can be happened assemble error and panel crack during assemble front cover

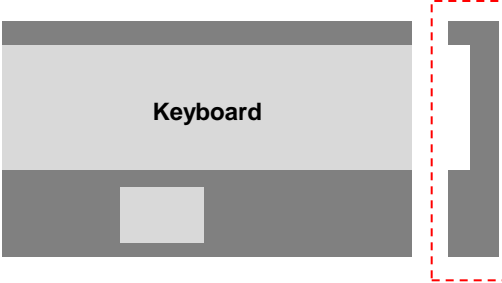
**LGD Proposal for system cover design.(Appendix)**

<p><b>9</b></p>	<p><b>Check mouse pad (touch pad) depth and shape of edge</b></p>
<div style="display: flex; align-items: flex-start;">  <div style="margin-left: 20px;">  <div style="border: 1px solid green; padding: 5px; margin-top: 10px;"> <p>[OK] <math>a \leq 0.3\text{mm}</math>              [CO] <math>0.5\text{mm} \geq a \geq 0.3\text{mm}</math>              [NG] <math>a \geq 0.5\text{mm}</math></p> </div> </div> </div> <div style="margin-top: 20px; display: flex; justify-content: space-around;"> <div style="text-align: center;">  <p><b>OK</b></p> </div> <div style="text-align: center;">  <p><b>NG</b></p> </div> </div> <p style="text-align: center; margin-top: 10px;">Mouse pad</p>	
<p>Define</p>	<p>1. Mouse pad step is deep, it is caused panel crack by external load.              .....              2. The edge shape must be smooth.</p>
<p><b>10</b></p>	<p><b>Check the step of keyboard area</b></p>
<div style="display: flex; justify-content: space-around; align-items: center;"> <div style="text-align: center;">  <p>Keyboard</p> <p>push</p>  <p><b>OK</b></p> </div> <div style="text-align: center;">  <p>Keyboard</p> <p>push</p>  <p><b>crack</b></p> <p><b>NG</b></p> </div> </div>	
<p>Define</p>	<p>1. The step of keyboard at the side edge of main body, it is caused panel crack</p>

## Product Specification

## 6. Reliability

Environment test condition

No.	Test Item	Conditions
1	High temperature storage test	Ta= 60°C, 240h
2	Low temperature storage test	Ta= -20°C, 240h
3	High temperature operation test	Ta= 50°C, 50%RH, 240h
4	Low temperature operation test	Ta= 0°C, 240h
5	Vibration test (non-operating)	Sine wave, 5 ~ 150Hz, 1.5G, 0.37oct/min 3 axis, 30min/axis
6	Shock test (non-operating)	- No functional or cosmetic defects following a shock to all 6 sides delivering at least 180 G in a half sine pulse no longer than 2 ms to the display module - No functional defects following a shock delivering at least 200 g in a half sine pulse no longer than 2 ms to each of 6 sides. Each of the 6 sides will be shock tested with one each display, for a total of 6 displays
7	Altitude operating storage / shipment	0 ~ 10,000 feet (3,048m) 24Hr 0 ~ 40,000 feet (12,192m) 24Hr

{ Result Evaluation Criteria }

There should be no change which might affect the practical display function when the display quality test is conducted under normal operating condition.



## 7. International Standards

### 7-1. Safety

- a) UL 60950-1, Second Edition, Underwriters Laboratories Inc.  
Information Technology Equipment - Safety - Part 1 : General Requirements.
- b) CAN/CSA C22.2 No.60950-1-07, Second Edition, Canadian Standards Association.  
Information Technology Equipment - Safety - Part 1 : General Requirements.
- c) EN 60950-1:2006 + A11:2009, European Committee for Electrotechnical Standardization (CENELEC).  
Information Technology Equipment - Safety - Part 1 : General Requirements.
- d) IEC 60950-1:2005, Second Edition, The International Electrotechnical Commission (IEC).  
Information Technology Equipment - Safety - Part 1 : General Requirements.

### 7-2. EMC

- a) ANSI C63.4 "American National Standard for Methods of Measurement of Radio-Noise Emissions from Low-Voltage Electrical and Electronic Equipment in the Range of 9 kHz to 40 GHz." American National Standards Institute (ANSI), 2003.
- b) CISPR 22 "Information technology equipment – Radio disturbance characteristics – Limit and methods of measurement." International Special Committee on Radio Interference (CISPR), 2005.
- c) CISPR 13 "Sound and television broadcast receivers and associated equipment – Radio disturbance characteristics – Limits and method of measurement." International Special Committee on Radio Interference (CISPR), 2006.

### 7-3. Environment

- a) RoHS, Directive 2002/95/EC of the European Parliament and of the council of 27 January 2003

## 8. Packing

### 8-1. Designation of Lot Mark

#### a) Lot Mark

A	B	C	D	E	F	G	H	I	J	K	L	M
---	---	---	---	---	---	---	---	---	---	---	---	---

A,B,C : SIZE(INCH)

E : MONTH

D : YEAR

F ~ M : SERIAL NO.

#### Note

##### 1. YEAR

Year	2011	2012	2013	2014	2015	2016	2017	2018	2019	2020
Mark	A	B	C	D	E	F	G	H	J	K

##### 2. MONTH

Month	Jan	Feb	Mar	Apr	May	Jun	Jul	Aug	Sep	Oct	Nov	Dec
Mark	1	2	3	4	5	6	7	8	9	A	B	C

#### b) Location of Lot Mark

Serial No. is printed on the label. The label is attached to the backside of the LCD module.  
 This is subject to change without prior notice.

### 8-2. Packing Form

a) Package quantity in one box : 20 pcs

b) Box Size : 478mm x 365mm x 328mm

## 9. PRECAUTIONS

Please pay attention to the followings when you use this TFT LCD module.

### 9-1. MOUNTING PRECAUTIONS

- (1) You must mount a module using holes arranged in four corners or four sides.
- (2) You should consider the mounting structure so that uneven force (ex. Twisted stress) is not applied to the module. And the case on which a module is mounted should have sufficient strength so that external force is not transmitted directly to the module.
- (3) Please attach the surface transparent protective plate to the surface in order to protect the polarizer. Transparent protective plate should have sufficient strength in order to resist external force.
- (4) You should adopt radiation structure to satisfy the temperature specification.
- (5) Acetic acid type and chlorine type materials for the cover case are not desirable because the former generates corrosive gas of attacking the polarizer at high temperature and the latter causes circuit break by electro-chemical reaction.
- (6) Do not touch, push or rub the exposed polarizers with glass, tweezers or anything harder than HB pencil lead. And please do not rub with dust clothes with chemical treatment. Do not touch the surface of polarizer for bare hand or greasy cloth.(Some cosmetics are detrimental to the polarizer.)
- (7) When the surface becomes dusty, please wipe gently with absorbent cotton or other soft materials like chamois soaks with petroleum benzene. Normal-hexane is recommended for cleaning the adhesives used to attach front / rear polarizers. Do not use acetone, toluene and alcohol because they cause chemical damage to the polarizer.
- (8) Wipe off saliva or water drops as soon as possible. Their long time contact with polarizer causes deformations and color fading.
- (9) Do not open the case because inside circuits do not have sufficient strength.
- (10) When handling the LCD module, it needs to handle with care not to give mechanical stress to the PCB and Mounting Hole area.”

### 9-2. OPERATING PRECAUTIONS

- (1) The spike noise causes the mis-operation of circuits. It should be lower than following voltage :  
 $V = \pm 200\text{mV}$ (Over and under shoot voltage)
- (2) Response time depends on the temperature.(In lower temperature, it becomes longer.)
- (3) Brightness depends on the temperature. (In lower temperature, it becomes lower.)  
And in lower temperature, response time(required time that brightness is stable after turned on) becomes longer.
- (4) Be careful for condensation at sudden temperature change. Condensation makes damage to polarizer or electrical contacted parts. And after fading condensation, smear or spot will occur.
- (5) When fixed patterns are displayed for a long time, remnant image is likely to occur.
- (6) Module has high frequency circuits. Sufficient suppression to the electromagnetic interference shall be done by system manufacturers. Grounding and shielding methods may be important to minimized the interference.

### 9-3. ELECTROSTATIC DISCHARGE CONTROL

Since a module is composed of electronic circuits, it is not strong to electrostatic discharge. Make certain that treatment persons are connected to ground through wrist band etc. And don't touch interface pin directly.

### 9-4. PRECAUTIONS FOR STRONG LIGHT EXPOSURE

Strong light exposure causes degradation of polarizer and color filter.

### 9-5. STORAGE

When storing modules as spares for a long time, the following precautions are necessary.

- (1) Store them in a dark place. Do not expose the module to sunlight or fluorescent light. Keep the temperature between 5°C and 35°C at normal humidity.
- (2) The polarizer surface should not come in contact with any other object.  
It is recommended that they be stored in the container in which they were shipped.

### 9-6. HANDLING PRECAUTIONS FOR PROTECTION FILM

- (1) When the protection film is peeled off, static electricity is generated between the film and polarizer.  
This should be peeled off slowly and carefully by people who are electrically grounded and with well ion-blown equipment or in such a condition, etc.
- (2) The protection film is attached to the polarizer with a small amount of glue. If some stress is applied to rub the protection film against the polarizer during the time you peel off the film, the glue is apt to remain on the polarizer.  
Please carefully peel off the protection film without rubbing it against the polarizer.
- (3) When the module with protection film attached is stored for a long time, sometimes there remains a very small amount of glue still on the polarizer after the protection film is peeled off.
- (4) You can remove the glue easily. When the glue remains on the polarizer surface or its vestige is recognized, please wipe them off with absorbent cotton waste or other soft material like chamois soaked with normal-hexane.

## Product Specification

**APPENDIX A. Enhanced Extended Display Identification Data (EEDID™) 1/3**

	Byte (Dec)	Byte (Hex)	Field Name and Comments	Value (Hex)	Value (Bin)
<b>Header</b>	0	00	Header	00	00000000
	1	01	Header	FF	11111111
	2	02	Header	FF	11111111
	3	03	Header	FF	11111111
	4	04	Header	FF	11111111
	5	05	Header	FF	11111111
	6	06	Header	FF	11111111
	7	07	Header	00	00000000
<b>Vendor / Product EDID Version</b>	8	08	ID Manufacture Name LGD	30	00110000
	9	09	ID Manufacture Name	E4	11100100
	10	0A	ID Product Code 03E6h	E6	11100110
	11	0B	( Hex. LSB first )	03	00000011
	12	0C	ID Serial No. - Optional ("00h" If not used, Number Only and LSB First)	00	00000000
	13	0D	ID Serial No. - Optional ("00h" If not used, Number Only and LSB First)	00	00000000
	14	0E	ID Serial No. - Optional ("00h" If not used, Number Only and LSB First)	00	00000000
	15	0F	ID Serial No. - Optional ("00h" If not used, Number Only and LSB First)	00	00000000
	16	10	Week of Manufacture - Optinal 00 weeks	00	00000000
	17	11	Year of Manufacture 2012 years	16	00010110
	18	12	EDID structure version # = 1	01	00000001
19	13	EDID revision # = 4	04	00000100	
<b>Display Parameters</b>	20	14	Video input Definition = Input is a Digital Video signal Interface , Colo Bit Depth : 6 Bits per Primary Color , Digital Vid	95	10010101
	21	15	Horizontal Screen Size (Rounded cm) = 35 cm	23	00100011
	22	16	Vertical Screen Size (Rounded cm) = 19 cm	13	00010011
	23	17	Display Transfer Characteristic (Gamma) = (gamma*100)-100 = Example:(2.2*100)-100=120	78	01111000
<b>Panel Color Coordinates</b>	24	18	Feature Support ( Display Power Management(DPM) : Standby mode is supported, Suspend mode is not supported, Active Off = Very Low Power is supported ,Supported Color Encoding Formats : RGB 4:4:4 & YCrCb 4:4:4 ,Other	EA	11101010
	25	19	Red/Green Low Bits (RxRy/GxGy)	05	00000101
	26	1A	Blue/White Low Bits (BxBw/WxWy)	F5	11110101
	27	1B	Red X Rx = 0.578	94	10010100
	28	1C	Red Y Ry = 0.344	58	01011000
	29	1D	Green X Gx = 0.337	56	01010110
	30	1E	Green Y Gy = 0.571	92	10010010
	31	1F	Blue X Bx = 0.159	28	00101000
	32	20	Blue Y By = 0.120	1E	00011110
	33	21	White X Wx = 0.313	50	01010000
<b>Established Timings</b>	34	22	White Y Wy = 0.329	54	01010100
	35	23	Established timing 1 ( Optional_00h if not used)	00	00000000
	36	24	Established timing 2 ( Optional_00h if not used)	00	00000000
<b>Standard Timing ID</b>	37	25	Manufacturer's timings ( Optional_00h if not used)	00	00000000
	38	26	Standard timing ID1 ( Optional_01h if not used)	01	00000001
	39	27	Standard timing ID1 ( Optional_01h if not used)	01	00000001
	40	28	Standard timing ID2 ( Optional_01h if not used)	01	00000001
	41	29	Standard timing ID2 ( Optional_01h if not used)	01	00000001
	42	2A	Standard timing ID3 ( Optional_01h if not used)	01	00000001
	43	2B	Standard timing ID3 ( Optional_01h if not used)	01	00000001
	44	2C	Standard timing ID4 ( Optional_01h if not used)	01	00000001
	45	2D	Standard timing ID4 ( Optional_01h if not used)	01	00000001
	46	2E	Standard timing ID5 ( Optional_01h if not used)	01	00000001
	47	2F	Standard timing ID5 ( Optional_01h if not used)	01	00000001
	48	30	Standard timing ID6 ( Optional_01h if not used)	01	00000001
	49	31	Standard timing ID6 ( Optional_01h if not used)	01	00000001
	50	32	Standard timing ID7 ( Optional_01h if not used)	01	00000001
	51	33	Standard timing ID7 ( Optional_01h if not used)	01	00000001
	52	34	Standard timing ID8 ( Optional_01h if not used)	01	00000001
	53	35	Standard timing ID8 ( Optional_01h if not used)	01	00000001

**Product Specification**
**APPENDIX A. Enhanced Extended Display Identification Data (EEDID™) 2/3**

	Byte (Dec)	Byte (Hex)	Field Name and Comments	Value (Hex)	Value (Bin)
<b>Timing Descriptor #1</b>	54	36	Pixel Clock/10,000 (LSB) <span style="float:right">76.3 MHz @ 60 Hz</span>	CE	11001110
	55	37	Pixel Clock/10,000 (MSB)	1D	00011101
	56	38	Horizontal Active (HA) (lower 8 bits) <span style="float:right">1366 pixels</span>	56	01010110
	57	39	Horizontal Blanking (HB) (lower 8 bits) <span style="float:right">244 pixels</span>	F4	11110100
	58	3A	Horizontal Active (HA) / Horizontal Blanking (HB) (upper 4:4bits)	50	01010000
	59	3B	Vertical Active (VA) <span style="float:right">768 lines</span>	00	00000000
	60	3C	Vertical Blanking (VB) (DE Blanking typ.for DE only panels) <span style="float:right">22 lines</span>	16	00010110
	61	3D	Vertical Active (VA) / Vertical Blanking (VB) (upper 4:4bits)	30	00110000
	62	3E	Horizontal Front Porch in pixels (HF) (lower 8 bits) <span style="float:right">48 pixels</span>	30	00110000
	63	3F	Horizontal Sync Pulse Width in pixels (HS) (lower 8 bits) <span style="float:right">32 pixels</span>	20	00100000
	64	40	Vertical Front Porch in lines (VF) : Vertical Sync Pulse Width in lines (VS) (lower 4 bits) <span style="float:right">3 lines : 5 lines</span>	35	00110101
	65	41	Horizontal Front Porch/ Sync Pulse Width/ Vertical Front Porch/ Sync Pulse Width (upper 2bits)	00	00000000
	66	42	Horizontal Video Image Size (mm) (lower 8 bits) <span style="float:right">345 mm</span>	59	01011001
	67	43	Vertical Video Image Size (mm) (lower 8 bits) <span style="float:right">194 mm</span>	C2	11000010
	68	44	Horizontal Image Size / Vertical Image Size (upper 4 bits)	10	00010000
69	45	Horizontal Border = 0 (Zero for Notebook LCD)	00	00000000	
70	46	Vertical Border = 0 (Zero for Notebook LCD)	00	00000000	
71	47	Non-Interlace, Normal display, no stereo, Digital Separate [ Vsync_NEG, Hsync_NEG (outside of V-sync) ]	19	00011001	
<b>Timing Descriptor #2</b>	72	48	Flag	00	00000000
	73	49	Flag	00	00000000
	74	4A	Flag	00	00000000
	75	4B	Data Type Tag (Descriptor Defined by manufacturer )	00	00000000
	76	4C	Flag	00	00000000
	77	4D	Descriptor Defined by manufacturer	00	00000000
	78	4E	Descriptor Defined by manufacturer	00	00000000
	79	4F	Descriptor Defined by manufacturer	00	00000000
	80	50	Descriptor Defined by manufacturer	00	00000000
	81	51	Descriptor Defined by manufacturer	00	00000000
	82	52	Descriptor Defined by manufacturer	00	00000000
	83	53	Descriptor Defined by manufacturer	00	00000000
	84	54	Descriptor Defined by manufacturer	00	00000000
	85	55	Descriptor Defined by manufacturer	00	00000000
	86	56	Descriptor Defined by manufacturer	00	00000000
87	57	Descriptor Defined by manufacturer	00	00000000	
88	58	Descriptor Defined by manufacturer	00	00000000	
89	59	Descriptor Defined by manufacturer	00	00000000	
<b>Timing Descriptor #3</b>	90	5A	Flag	00	00000000
	91	5B	Flag	00	00000000
	92	5C	Flag	00	00000000
	93	5D	Data Type Tag ( Alphanumeric Data String (ASCII String) )	FE	11111110
	94	5E	Flag	00	00000000
	95	5F	Alphanumeric Data String (ASCII String) <span style="float:right">L</span>	4C	01001100
	96	60	Alphanumeric Data String (ASCII String) <span style="float:right">G</span>	47	01000111
	97	61	Alphanumeric Data String (ASCII String)	20	00100000
	98	62	Alphanumeric Data String (ASCII String) <span style="float:right">D</span>	44	01000100
	99	63	Alphanumeric Data String (ASCII String) <span style="float:right">i</span>	69	01101001
	100	64	Alphanumeric Data String (ASCII String) <span style="float:right">s</span>	73	01110011
	101	65	Alphanumeric Data String (ASCII String) <span style="float:right">p</span>	70	01110000
	102	66	Alphanumeric Data String (ASCII String) <span style="float:right">l</span>	6C	01101100
	103	67	Alphanumeric Data String (ASCII String) <span style="float:right">a</span>	61	01100001
	104	68	Alphanumeric Data String (ASCII String) <span style="float:right">y</span>	79	01111001
105	69	Manufacturer P/N(If<13 char--> 0Ah, then terminate with ASC II code 0Ah,set remaining char = 20h)	0A	00001010	
106	6A	Manufacturer P/N(If<13 char--> 0Ah, then terminate with ASC II code 0Ah,set remaining char = 20h)	20	00100000	
107	6B	Manufacturer P/N(If<13 char--> 0Ah, then terminate with ASC II code 0Ah,set remaining char = 20h)	20	00100000	

## Product Specification

**APPENDIX A. Enhanced Extended Display Identification Data (EEDID™) 3/3**

	Byte (Dec)	Byte (Hex)	Field Name and Comments	Value (Hex)	Value (Bin)
<i>Timing Descriptor #4</i>	108	6C	Flag	00	00000000
	109	6D	Flag	00	00000000
	110	6E	Flag	00	00000000
	111	6F	Data Type Tag ( Alphanumeric Data String (ASCII String) )	FE	11111110
	112	70	Flag	00	00000000
	113	71	Alphanumeric Data String (ASCII String) L	4C	01001100
	114	72	Alphanumeric Data String (ASCII String) P	50	01010000
	115	73	Alphanumeric Data String (ASCII String) 1	31	00110001
	116	74	Alphanumeric Data String (ASCII String) 5	35	00110101
	117	75	Alphanumeric Data String (ASCII String) 6	36	00110110
	118	76	Alphanumeric Data String (ASCII String) W	57	01010111
	119	77	Alphanumeric Data String (ASCII String) H	48	01001000
	120	78	Alphanumeric Data String (ASCII String) U	55	01010101
	121	79	Alphanumeric Data String (ASCII String) -	2D	00101101
	122	7A	Alphanumeric Data String (ASCII String) T	54	01010100
123	7B	Alphanumeric Data String (ASCII String) P	50	01010000	
124	7C	Alphanumeric Data String (ASCII String) A	41	01000001	
125	7D	Alphanumeric Data String (ASCII String) 1	31	00110001	
<i>Checksum</i>	126	7E	Extension flag (# of optional 128 panel ID extension block to follow, Typ = 0)	00	00000000
	127	7F	Check Sum (The 1-byte sum of all 128 bytes in this panel ID block shall = 0)	24	00100100